

Rea® Clematis® Pro Configured

Please contact Invacare EU Export Customer Services on :-
 Tel : +33 247 626980 ; Email : serviceclient_export@invacare.com
 Or visit our website : www.invacare.eu.com



Rea® Clematis® Pro Configured

Folding Frame Steel Manual Comfort Chair



Date :

Purchase Order :

Customer Code :

Distributor Stamp:



Description:

- Seat and backrest reclining by pneumatic cylinders (from 0° to + 25° / -3° to + 22° for the seat, from 0° to + 30° for the backrest)
- Width adjustment of armrests (+ 25 mm per side) and legrests (+ 50 mm per side)
- Infinitely adjustable seat depth from 430 to 500 mm
- Neck support
- Pair of legrests with articulated pallets
- Colour Pearly Beige (RAL 1035)
- Maximum user weight: 135 kg.
- Weight: from 30 kg
- 2-year warranty period excluding wear parts
- Compatible with Alber Power Add-Ons : e-motion M25, e-fix E35-E36, viamobil V25, viaplus V12

Please make your selection with a cross in the box ◆ Standard feature ○ Free of charge option

| CODE | DESCRIPTION | NC : Non Compatible NC : 9999 = not compatible with the reference 9999 | Euros | |
|---|--|--|--------|---|
| SNB0001 | <input type="checkbox"/> Rea® Clematis® Pro | | 942,64 | |
| PROPULSION TYPE | | | | |
| SNB0100 | <input type="checkbox"/> SELF PROPULSION (24" REAR WHEELS) | NC : 1500 | | ◆ |
| SNB0110 | <input type="checkbox"/> TRANSIT PROPULSION (12" REAR WHEELS) | NC : 0380, 1510, 1520 | | ○ |
| FRAME | | | | |
| FRAME TYPE | | | | |
| SNB0210 | <input type="checkbox"/> ADJUSTABLE FRAME DEPTH AND WIDTH ADJUSTABLE | | | ◆ |
| SEAT WIDTH | | | | |
| SNB0300 | <input type="checkbox"/> 390mm, adjustable to 440mm | | | ○ |
| SNB0310 | <input type="checkbox"/> 440mm, adjustable to 490mm | | | ○ |
| SNB0320 | <input type="checkbox"/> 490mm, adjustable to 540mm | | | ○ |
| SNB0330 | <input type="checkbox"/> 540mm, adjustable to 590mm | NC : 0430, 1630, 1640 | 545,02 | |
| SEAT DEPTH | | | | |
| SNB0370 | <input type="checkbox"/> Infinitely adjustable from 430 to 500 mm | | | ◆ |
| Floor/seat height (measured without cushion) | | | | |
| SNB0380 | <input type="checkbox"/> 400 mm | NC : 1430, 1440 | | ○ |
| SNB0390 | <input type="checkbox"/> 450 mm | | | ◆ |
| SEAT CUSHIONS | | | | |
| SNB0410 | <input type="checkbox"/> CUSHION MATRX CONTOUR VISCO NG | | | ◆ |
| SNB0420 | <input type="checkbox"/> CUSHION MISTRAL 2 BLACK PU TR26 | | -43,70 | |
| SNB0430 | <input type="checkbox"/> CUSHION FLO-SHAPE BLACK PU TR26 | | -43,70 | |
| BACKREST TYPE | | | | |
| SNB0500 | <input type="checkbox"/> RIGID BACKREST PLATE | NC : 0540, 1000 | | ◆ |
| SNB0510 | <input type="checkbox"/> SOFT FABRIC BACKREST | NC : 0540, 1000 | | ○ |
| SNB0520 | <input type="checkbox"/> BACKREST LAGUNA 2 TENSION ADJUSTABLE | NC : 0560, 0570, 1200, 1210, 1220, 1230 | 173,46 | |
| BACKREST CUSHION | | | | |
| SNB0530 | <input type="checkbox"/> CUSHION LAGUNA 2 BLACK PU TR26 | | | ◆ |
| SNB0540 | <input type="checkbox"/> COVER LATERAL BLACK PU TR26 | | | ○ |

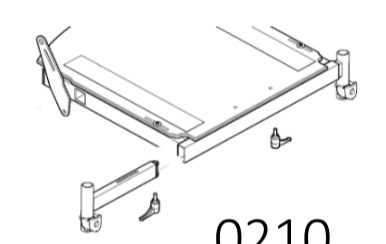

0210



STD
+25 mm
par côté



0410

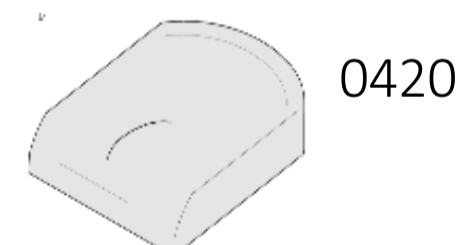

0420

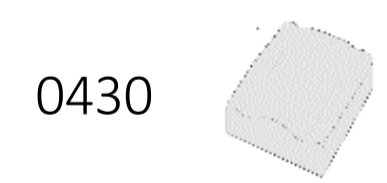

0430

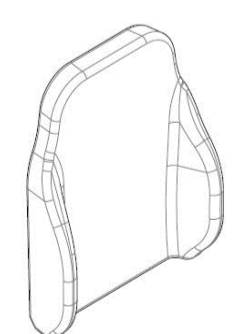

0530

| PUSH HANDLES | | | |
|---|--------------------------|--|---------------------------------------|
| SNB0560 | <input type="checkbox"/> | HEIGHT ADJUSTABLE PUSH HANDLES | ◆ |
| SNB0570 | <input type="checkbox"/> | PUSH BAR ANGLE ADJUSTABLE | 145,97 |
| SNB0580 | <input type="checkbox"/> | COMBINED PUSH HANDLES | ○ |
| SEAT TILT AND BACKREST REGULATION TYPE | | | |
| SNB0600 | <input type="checkbox"/> | ASSISTANT OPERATED GAS PISTON BACKREST AND SEAT TILT | ◆ |
| TILT LOCK | | | |
| SNB0630 | <input type="checkbox"/> | TILT LOCK (LOCKING OF PRE-SET ANGLE) | ◆ |
| LEGRESTS / FOOTRESTS | | | |
| LEGRESTS ADJUSTMENT | | | |
| SNB0700 | <input type="checkbox"/> | STANDARD LEGREST ATTACHMENT | ◆ |
| SNB0710 | <input type="checkbox"/> | 90° HANGER ATTACHMENT | 52,13 |
| LEGRESTS LH TYPE | | | |
| SNB0720 | <input type="checkbox"/> | LEGREST ANGLE ADJUSTABLE, INCL CALF SUPPORT, LH | ◆ |
| LEGRESTS RH TYPE | | | |
| SNB0740 | <input type="checkbox"/> | LEGREST ANGLE ADJUSTABLE, INCL CALF SUPPORT, RH | ◆ |
| FOOTRESTS | | | |
| FOOTRESTS LH TYPE | | | |
| SNB0770 | <input type="checkbox"/> | FOOTREST LOWER PART, DEPTH, WIDTH AND ANGLE ADJUSTABLE WITH HEEL STRAP, LH | ◆ |
| FOOTRESTS RH TYPE | | | |
| SNB0790 | <input type="checkbox"/> | FOOTREST LOWER PART, DEPTH, WIDTH AND ANGLE ADJUSTABLE WITH HEEL STRAP, RH | ◆ |
| ARMRESTS (Height adjustable, auto lock attachment included) | | | |
| ARMREST LH TYPE | | | |
| SNB0800 | <input type="checkbox"/> | STANDARD PAD, LH - DEPTH ADJUSTABLE | ◆ |
| SNB0810 | <input type="checkbox"/> | COMFORT ARMREST PAD, LH - DEPTH ADJUSTABLE and CONCAVE SHAPE | NC : 1720 113,17 |
| SNB0820 | <input type="checkbox"/> | HEMIPLEGIC ARMREST ,LH | NC : 1700, 1710, 1720, 1790 113,17 |
| ARMREST RH TYPE | | | |
| SNB0850 | <input type="checkbox"/> | STANDARD PAD, RH - DEPTH ADJUSTABLE | ◆ |
| SNB0860 | <input type="checkbox"/> | COMFORT ARMREST PAD, RH - DEPTH ADJUSTABLE and CONCAVE SHAPE | NC : 1730 113,17 |
| SNB0870 | <input type="checkbox"/> | HEMIPLEGIC ARMREST,RH | NC : 1700, 1710, 1730, 1790 113,17 |
| SEATING OPTIONS | | | |
| SEATING OPTIONS | | | |
| SNB0910 | <input type="checkbox"/> | ABDUCTION CUSHION | 246,45 |
| BACKREST OPTIONS TYPE | | | |
| SNB1000 | <input type="checkbox"/> | SUPPORT STRAP FOR BACKREST LAGUNA 2 TENSION ADJUSTABLE | 38,86 |
| HEADREST/ NECKREST | | | |
| SNB1100 | <input type="checkbox"/> | HEADREST ADJUSTABLE WITH HANDWHEEL | 209,48 |
| SNB1110 | <input type="checkbox"/> | HEADREST WITH CHEEK SUPPORT, SIDEWISE ADJUSTABLE | NC : 1130 225,59 |
| SNB1120 | <input type="checkbox"/> | NECKREST FIXED | NC : 1130 ◆ |
| SNB1130 | <input type="checkbox"/> | COVER FOR HEADREST | 57,82 |
| TRUNK SUPPORT LH | | | |
| SNB1200 | <input type="checkbox"/> | TRUNK SUPPORT SMALL, LH | 174,41 |
| SNB1210 | <input type="checkbox"/> | TRUNK SUPPORT SWINGAWAY (LH) | 156,40 |
| SNB1220 | <input type="checkbox"/> | TRUNK SUPPORT SMALL, RH | 174,41 |
| SNB1230 | <input type="checkbox"/> | TRUNK SUPPORT SWINGAWAY (RH) | 156,40 |
| LEGREST / FOOTREST OPTIONS TYPE | | | |
| SNB1300 | <input type="checkbox"/> | FOOTPLATE PADDING | 103,32 |

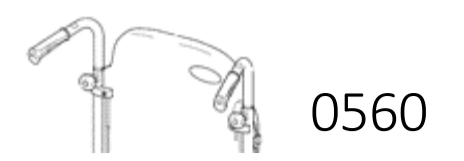

0560

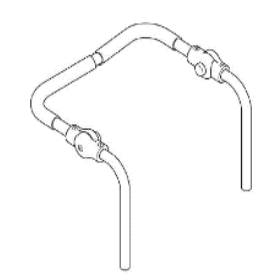

0570

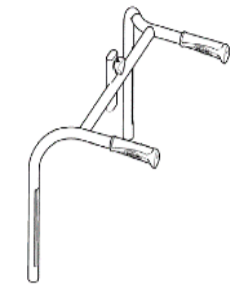

0580

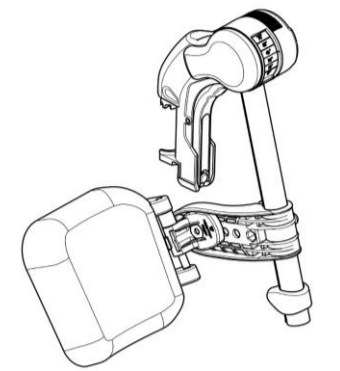
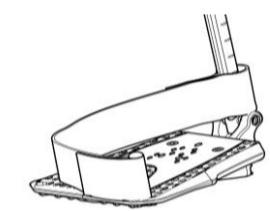
0720
0740

0770

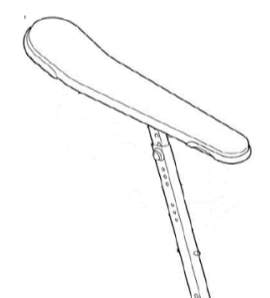

0800



0810

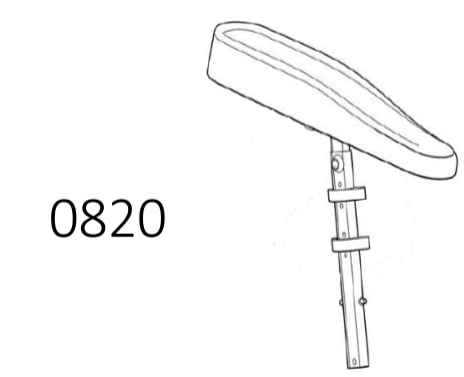

0820

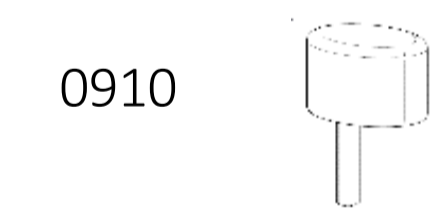

0910

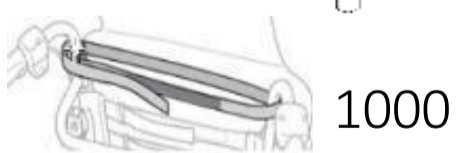

1000

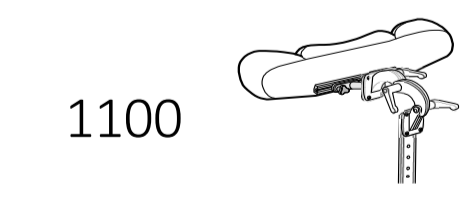

1100

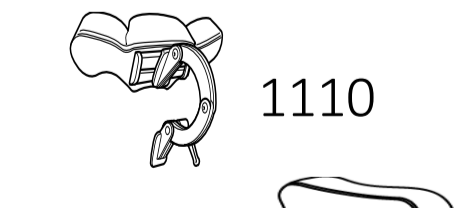

1110



1120

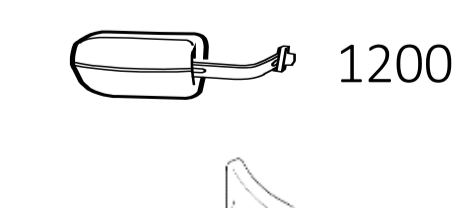



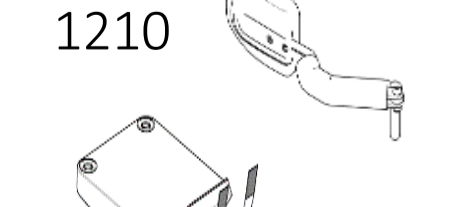



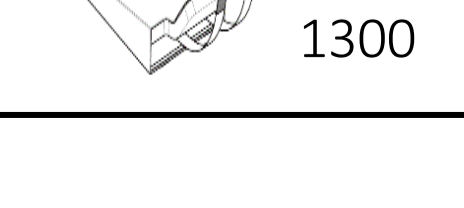



1200

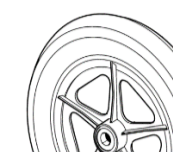

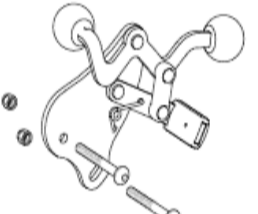
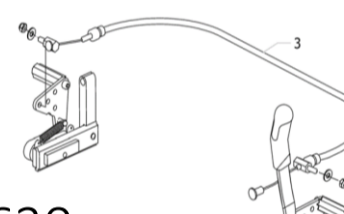
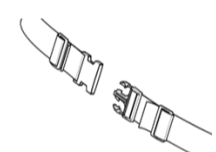
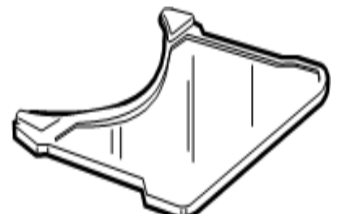
1210

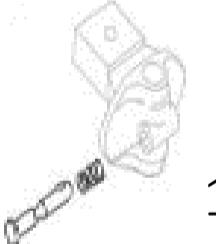

1300

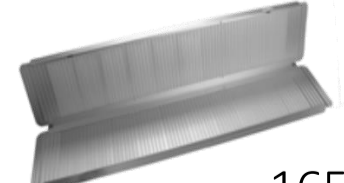
| CHASSIS | | | | | |
|-------------------------------|--------------------------|---|---|----------|---|
| CHASSIS COLOURS | | | | | |
| SNB1400 | <input type="checkbox"/> | PEARL BEIGE | | ◆ |  1420 |
| CASTOR ATTACHMENT TYPE | | | | | |
| SNB1410 | <input type="checkbox"/> | CASTOR ATTACHMENT FIXED | | ◆ |  1430 |
| FRONT CASTORS | | | | | |
| SNB1420 | <input type="checkbox"/> | 6"x1.1/4" - 150X30 MM BLACK SOLID TYRE | | ◆ |  1440 |
| SNB1430 | <input type="checkbox"/> | 8"x1.1/4" - 200X30 MM BLACK SOLID TYRE | | ○ | |
| SNB1440 | <input type="checkbox"/> | 8"x2" - 200X45 MM BLACK SOLID TYRE | | ○ | |
| REAR WHEELS SIZE/TYPE | | | | | |
| SNB1500 | <input type="checkbox"/> | 12" (305 MM) WHEEL - QR ATTACHMENT | NC : 1530, 1550, 1560, 1600, 1630, 1640 | ○ |  1500 |
| SNB1510 | <input type="checkbox"/> | 24" (610 MM) REINFORCED REAR WHEELS - QR ATTACHMENT | NC : 1620 | 36,02 |  1510 |
| SNB1520 | <input type="checkbox"/> | 24" (610 MM) STANDARD WHEELS - QR ATTACHMENT | NC : 1620 | ◆ | |
| SNB1525 | <input type="checkbox"/> | 24" (610 MM) DRUM BRAKE WHEELS - QR ATTACHMENT / WITH FIXED FRAME ARMREST SPACER +25 MM INCLUDED | NC : 1620, 1630, 1640 | 213,27 | |
| TYRE TYPE | | | | | |
| SNB1530 | <input type="checkbox"/> | BLACK PNEUMATIC PROFILED | | ○ | |
| SNB1540 | <input type="checkbox"/> | BLACK TYRES SOLID | | ◆ | |
| HANDRIM TYPE | | | | | |
| SNB1550 | <input type="checkbox"/> | Aluminium | | ◆ |  1520 |
| OPTIONS | | | | | |
| SPOKEGUARD | | | | | |
| SNB1560 | <input type="checkbox"/> | FROST | | 219,91 | |
| SAFETY | | | | | |
| SNB1600 | <input type="checkbox"/> | STANDARD BRAKES | | ◆ | |
| SNB1620 | <input type="checkbox"/> | FOOT OPERATED BRAKES - ONLY FOR 12" REAR WHEELS | | ○ |  1620 |
| SNB1630 | <input type="checkbox"/> | ONE ARM BRAKE LH | | 327,01 | |
| SNB1640 | <input type="checkbox"/> | ONE ARM BRAKE RH | | 327,01 |  |
| SAFETY OPTIONS | | | | | |
| SNB1650 | <input type="checkbox"/> | POSTURE BELT - PLASTIC BUCKLE | | ○ |  1650 |
| SNB1660 | <input type="checkbox"/> | ANTI-TIP DEVICE - INCLUDED IN THE CHASSIS | | ◆ | |
| SNB1680 | <input type="checkbox"/> | TRANSPORTATION KIT (WITHOUT POSTURE BELT) - NOT POSSIBLE WITH E-TILT VERSION | | 24,64 | |
| OPTIONS | | | | | |
| SNB1700 | <input type="checkbox"/> | TABLE TRAY INCL MOUNTING KIT, WITH ELBOW PADS | NC : 1750 | 154,50 | |
| SNB1710 | <input type="checkbox"/> | TABLE TRAY INCL MOUNTING KIT | NC : 1750 | 72,83 |  1710 |
| SNB1720 | <input type="checkbox"/> | HALF TABLE TRAY, CLEAR, FLIP UP, LH WITH STRAIGHT NARROW PAD | NC : 1740 | 72,83 | |
| SNB1730 | <input type="checkbox"/> | HALF TABLE TRAY, CLEAR, FLIP UP, RH WITH STRAIGHT NARROW PAD | NC : 1740 | 72,83 | |
| SNB1740 | <input type="checkbox"/> | TABLE TRAY CUSHION | | 101,42 |  1750 |
| SNB1750 | <input type="checkbox"/> | PADDING FOR HALF TABLE TRAY | | 90,05 | |
| SNB1770 | <input type="checkbox"/> | MOUNTING BRACKET VIAMOBIL V25 | | 313,74 | |
| SNB1780 | <input type="checkbox"/> | DRIP STAND | | 103,32 |  1790 |
| SNB1790 | <input type="checkbox"/> | LOCKING DEVICE FOR TABLE TRAY | | 59,72 | |
| RAMPS | | | | | |
| 1440530 | <input type="checkbox"/> | Fiberglass Folding Mono Ramp Folded dimensions: 2000 x 230 mm 16.3 kg - maximum capacity: 300 kg | | 1 787,68 |  1440530 |
| 1654128 | <input type="checkbox"/> | Basic ramp 2 telescopic parts in aluminum and non-slip coating. Folded dimensions: 1210 x 194 mm. 8.8 kg per pair - maximum capacity: 270 kg | | 402,84 |  1654128 |
| 1654129 | <input type="checkbox"/> | Quick2go Compact 3-part aluminum telescopic ramp with non-slip coating Folded dimensions: 870 x 237 mm 13.6 kg per pair - maximum capacity: 260 kg | | 805,69 |  1654129 |
| 1654130 | <input type="checkbox"/> | Aluminium folding mono ramp Folded dimensions: 1824 x 714 mm 13.9 kg - maximum capacity: 300 kg | | 426,54 |  1654130 |