

# Invacare® Action®<sup>3</sup><sub>NG</sub> OAD

Please contact Invacare EU Export Customer Services on :-  
Tel : +33 247 626980 ; Email : serviceclient\_export@invacare.com  
Or visit our website : www.invacare.eu.com



## Invacare® Action®<sup>3</sup><sub>NG</sub> ONE ARM DRIVE (OAD)

Fauteuil manuel en aluminium pliant par croisillon



### Description:

- Propulsion, steering and braking by pendular lever
- Weight: from 18 kg.
- Maximum user weight: 125 kg.
- 2-year warranty period excluding wear parts

Date :

Purchase Order :

Customer Code :

Distributor Stamp::



Invacare Unique Customization Service

Please specify the quote or special production number:

Please make your selection with a cross in the box

◆ Standard feature



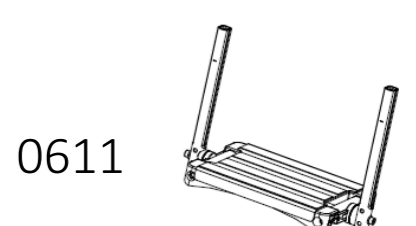
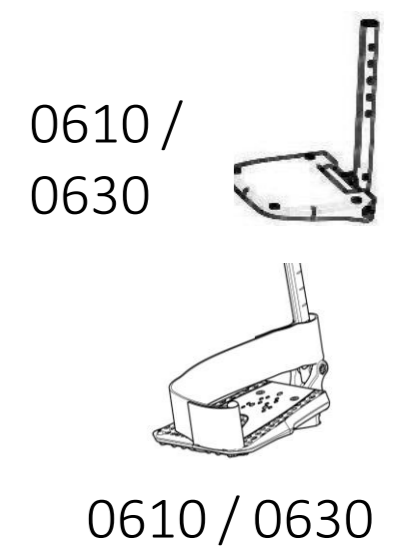
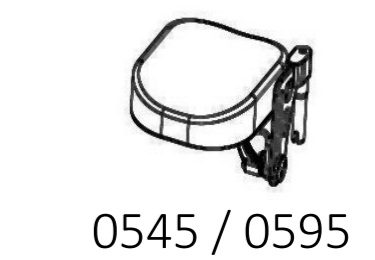
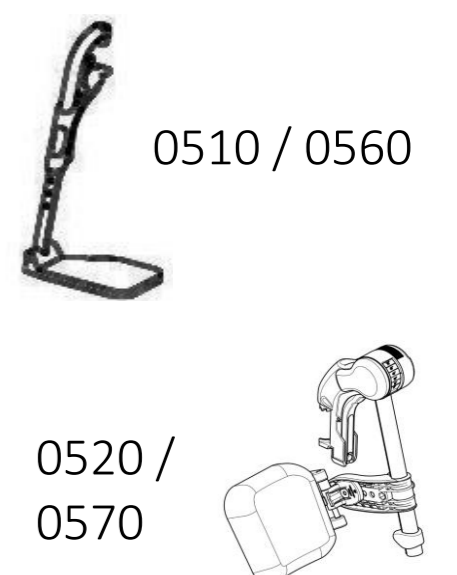
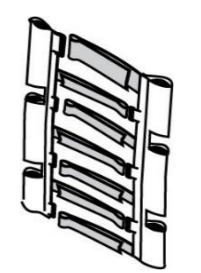
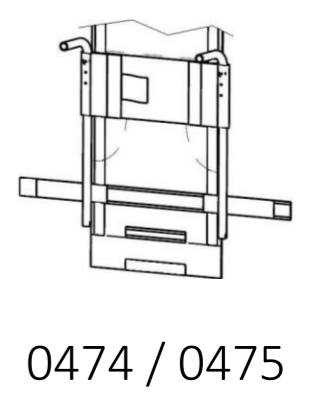
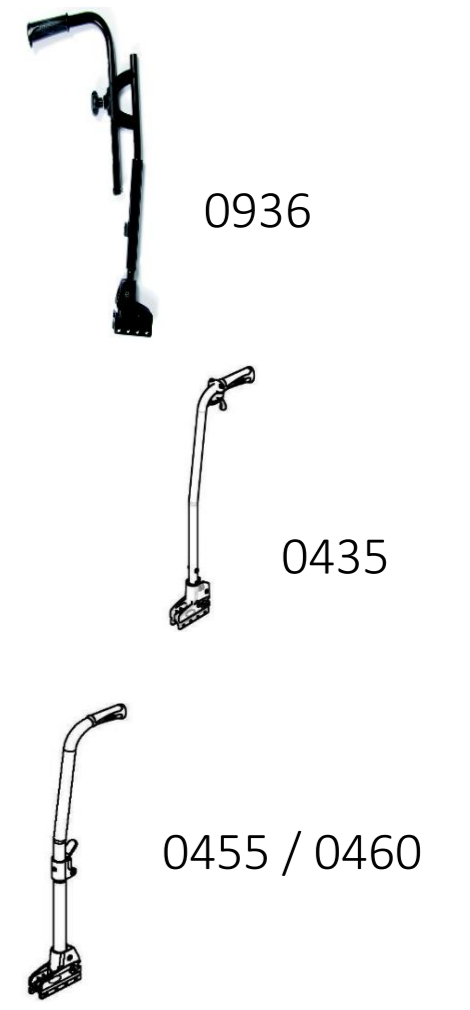

○ Free of charge option

CODE		DESCRIPTION	NC : Non Compatible NC : 9999 = not compatible with the reference 9999	Euros
CEI0031	<input type="checkbox"/>	Invacare® Action® <sup>3</sup> <sub>NG</sub> OAD - Fixed Backrest		529,85
CEI0036	<input type="checkbox"/>	Invacare® Action® <sup>3</sup> <sub>NG</sub> OAD - Folding Backrest		572,18
CEI0041	<input type="checkbox"/>	Invacare® Action® <sup>3</sup> <sub>NG</sub> OAD - Reclining Backrest		572,18
<b>PROPULSION TYPE</b>				
CEI0160	<input type="checkbox"/>	OAD BY LEVER RH PROPULSION	NC : 0732	1274,88
CEI0170	<input type="checkbox"/>	OAD BY LEVER LH PROPULSION	NC : 0832	1274,88
<b>SEAT</b>				
<b>SEAT WIDTH</b>				
CEI0180	<input type="checkbox"/>	380 mm	NC : 0545+0595, 0852, 0855	○
CEI0190	<input type="checkbox"/>	405 mm	NC : 0545+0595	○
CEI0200	<input type="checkbox"/>	430 mm	NC : 0853	◆
CEI0210	<input type="checkbox"/>	455 mm	NC : 0853	○
CEI0220	<input type="checkbox"/>	480 mm	NC : 0853, 0854	○
CEI0230	<input type="checkbox"/>	505 mm	NC : 0853, 0854, 0855, 0856	○
<b>SEAT DEPTH</b>				
CEI0240	<input type="checkbox"/>	400 mm	NC : 0879	◆
CEI0250	<input type="checkbox"/>	450 mm	NC : 0853, 0878	○
CEI0252	<input type="checkbox"/>	400 TO 450 MM ADJUSTABLE SEAT DEPTH	NC : 0330, 0350	30,33
<b>SEAT HEIGHT</b>				
CEI0260	<input type="checkbox"/>	510 mm	NC : 1035	○
CEI0270	<input type="checkbox"/>	485 mm		◆
CEI0280	<input type="checkbox"/>	460 mm	NC : 1345	○
<b>SEAT UPHOLSTERY TYPE</b>				
CEI0330	<input type="checkbox"/>	NYLON WITHOUT LOOP BANDS SEAT UPHOLSTERY		◆
CEI0340	<input type="checkbox"/>	NYLON WITH LOOP BANDS SEAT UPHOLSTERY		○
CEI0350	<input type="checkbox"/>	PADDED NYLON SEAT UPHOLSTERY		30,33

BACKREST				
<b>BACKREST TYPE - Anti-tippers required with reclining backrests</b>				
CEI0395	<input type="checkbox"/>	FIXED 7° BACKREST - HEIGHT ADJUST 380 TO 460 MM (DELIVERED 380 MM)	NC : 0474, 0475, 0478, 0479, 0481, 0905, 0906, 0907, 0940, 1451	295,73
CEI0396	<input type="checkbox"/>	FIXED 7° BACKREST - HEIGHT ADJUST 380 TO 460 MM (DELIVERED 380 MM)	NC : 0474, 0475, 0478, 0479, 0481, 0905, 0906, 0907, 0940, 1451	295,73
CEI0410	<input type="checkbox"/>	FIXED 7° BACKREST - 2 HEIGHTS 400/430 MM (DELIV. 430 MM)	NC : 0945	◆
CEI0420	<input type="checkbox"/>	FIXED 7° BACKREST - 510 MM HEIGHT	NC : 0945	33,18
CEI0435	<input type="checkbox"/>	RECLINING (RATCHET) 0/30° BACKREST INCL. BACKRACE & PASSIVE REAR WHEEL POS. ONLY - 3 HEIGHTS 390/410/430 MM (DELIV.430 MM)	NC : 0940, 0945	◆
CEI0445	<input type="checkbox"/>	RECLINING (GAS SPRING) 0/30° BACKREST INCL. BACKRACE & PASSIVE REAR WHEEL POS. ONLY - 3 HEIGHTS 390/410/430 MM (DELIV.430 MM)	NC : 0940, 0945	○
CEI0450	<input type="checkbox"/>	RECLINING (GAS SPRING) 0/30° BACKREST INCL. BACKRACE & PASSIVE REAR WHEEL POS. ONLY - 3 HEIGHTS 470/490/510 MM (DELIV.510 MM)	NC : 0940, 0945	33,18
CEI0455	<input type="checkbox"/>	FOLDING 7° BACKREST - 430 MM HEIGHT	NC : 0945	◆
<b>BACKREST UPHOLSTERY TYPE</b>				
CEI0474	<input type="checkbox"/>	LUMBAR SUPPORT (+1 STRAP) BI MATERIAL PADDED COVER INCL. BACK POCKET		33,08
CEI0475	<input type="checkbox"/>	LUMBAR SUPPORT (+1 STRAP) PADDED SHAPED COVER		◆
CEI0478	<input type="checkbox"/>	CONTOUR ADJUSTABLE (3+1 STRAPS) BI MATERIAL PADDED COVER INCL. BACK POCKET	NC : 0940, 0945	66,16
CEI0479	<input type="checkbox"/>	CONTOUR ADJUSTABLE (3+1 STRAPS) PADDED SHAPED COVER	NC : 0940, 0945	33,08
CEI0480	<input type="checkbox"/>	CONTOUR ADJUSTABLE (7+1 STRAPS) PADDED SHAPED COVER	NC : 0940, 0945	138,39
CEI0481	<input type="checkbox"/>	CONTOUR ADJUSTABLE (7+1 STRAPS) BI MATERIAL PADDED COVER INCL. BACK POCKET	NC : 0940, 0945	189,57
<b>HANGERS/FOOTPLATES</b>				
<b>HANGERS RH TYPE</b>				
CEI0510	<input type="checkbox"/>	80° STRAIGHT RH SWING IN/SWING OUT HANGER		◆
CEI0520	<input type="checkbox"/>	ELEVATING LEGREST (0° TO 75°) RH SWING IN/SWING OUT HANGER (INCLUDING CALFPAD)	NC : 0611, 0930, 0935, 0936	73,82
CEI0545	<input type="checkbox"/>	AMPUTEE LEGREST RH	NC : 0600, 0610, 0611, 0930, 0936	140,28
<b>HANGERS LH TYPE</b>				
CEI0560	<input type="checkbox"/>	WITHOUT LH HANGER		◆
CEI0570	<input type="checkbox"/>	ELEVATING LEGREST (0° TO 75°) LH SWING IN/SWING OUT HANGER (INCLUDING CALFPAD)	NC : 0611, 0930, 0935, 0936	73,82
CEI0595	<input type="checkbox"/>	AMPUTEE LEGREST LH	NC : 0611, 0620, 0630, 0930, 0936	140,28
<b>FOOTPLATES RH TYPE</b>				
CEI0600	<input type="checkbox"/>	FLIP UP RH FOOTPLATE - (INCLUDING HEEL STRAP)		◆
CEI0610	<input type="checkbox"/>	FLIP UP DEPTH & ANGLE AJUSTABLE RH FOOTPLATE - (INCLUDING HEEL STRAP)		26,43
CEI0611	<input type="checkbox"/>	FLIP UP ONE PIECE FOOTPLATE - DEPTH & ANGLE ADJUSTABLE	NC : 0620, 0630, 0935, 0936	203,79
<b>FOOTPLATES LH TYPE</b>				
CEI0620	<input type="checkbox"/>	FLIP UP LH FOOTPLATE - (INCLUDING HEEL STRAP)		◆
CEI0630	<input type="checkbox"/>	FLIP UP DEPTH & ANGLE AJUSTABLE LH FOOTPLATE - (INCLUDING HEEL STRAP)		26,43

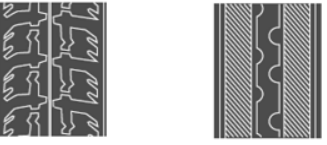
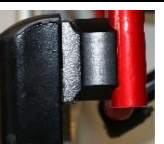

ARMRESTS					
<b>ARMRESTS RH FORM IN BLACK COLOR</b>					
CEI0656	<input type="checkbox"/>	REMOVABLE AND CONTINUOUSLY HEIGHT-ADJUSTABLE FROM 200 MM TO 280 MM - SHORT NARROW GUTTER (330 MM) WITHOUT ROTATION	NC : 0760, 0770, 0772, 0780, 0790, 0798, 1480	113,17	 0656 / 0756
CEI0660	<input type="checkbox"/>	SWING AWAY DETACHABLE RH (N°2) - DESK	NC : 0756, 0772, 0780, 0790, 1480	◆	
CEI0670	<input type="checkbox"/>	SWING AWAY DETACHABLE RH (N°2) - FULL LENGTH	NC : 0756, 0780, 0790, 0798	24,64	
CEI0672	<input type="checkbox"/>	LIFTABLE AND REMOVABLE, HEIGHT-ADJUSTABLE FROM 170 TO 295 MM - SHORT (330 MM) NON-ROTATING NARROW TROUGH WITH CLOTHES GUARD AND ERGONOMIC SUPPORT HANDLE	NC : 0760, 0770, 0798, 1480	113,17	 0660 / 0760
CEI0680	<input type="checkbox"/>	SWING AWAY DETACHABLE RH (N°3) - DESK	NC : 0756, 0760, 0770, 0798, 1480	117,54	
CEI0690	<input type="checkbox"/>	SWING AWAY DETACHABLE RH (N°3) - FULL LENGTH	NC : 0756, 0760, 0770	140,28	
CEI0698	<input type="checkbox"/>	REMOVABLE AND HEIGHT ADJUSTABLE - SHORT NARROW GUTTER (330 MM) WITHOUT ROTATION	NC : 0760, 0770, 0780, 0790	113,17	 0672 / 0772
CEI0732	<input type="checkbox"/>	REMOVABLE RH (N°4) AUTOLOCK SAFETY DEVICE INCLUDED - ARMPAD HEMI BLACK PU TR26	NC : 1480	113,17	
<b>ARMRESTS LH FORM IN BLACK COLOR</b>					
CEI0756	<input type="checkbox"/>	REMOVABLE AND CONTINUOUSLY HEIGHT-ADJUSTABLE FROM 200 MM TO 280 MM - SHORT NARROW GUTTER (330 MM) WITHOUT ROTATION		113,17	 0680 / 0780
CEI0760	<input type="checkbox"/>	SWING AWAY DETACHABLE LH (N°2) - DESK	NC : 1480	◆	
CEI0770	<input type="checkbox"/>	SWING AWAY DETACHABLE LH (N°2) - FULL LENGTH		24,64	
CEI0772	<input type="checkbox"/>	LIFTABLE AND REMOVABLE, HEIGHT-ADJUSTABLE FROM 170 TO 295 MM - SHORT (330 MM) NON-ROTATING NARROW TROUGH WITH CLOTHES GUARD AND ERGONOMIC SUPPORT HANDLE	NC : 1480	113,17	 0698 / 0798
CEI0780	<input type="checkbox"/>	SWING AWAY DETACHABLE LH (N°3) - DESK	NC : 1480	117,54	
CEI0790	<input type="checkbox"/>	SWING AWAY DETACHABLE LH (N°3) - FULL LENGTH		140,28	
CEI0798	<input type="checkbox"/>	REMOVABLE AND HEIGHT ADJUSTABLE - SHORT NARROW GUTTER (330 MM) WITHOUT ROTATION		113,17	
CEI0832	<input type="checkbox"/>	REMOVABLE LH (N°4) AUTOLOCK SAFETY DEVICE INCLUDED - ARMPAD HEMI BLACK PU TR26	NC : 1480	113,17	 0732 / 0832
<b>SEAT CUSHION TYPE</b>					
<b>Cushion</b>					
CEI0849	<input type="checkbox"/>	BASIC 60 MM FOAM CUSHION	NC : 0853, 0854, 0855, 0856, 0871, 0873	33,08	 0849
CEI0853	<input type="checkbox"/>	CLASSIC VISCO CUSHION 375X 400 MM	NC : 0871, 0873, 0878, 0879	76,78	
CEI0854	<input type="checkbox"/>	CLASSIC VISCO CUSHION 405 X 400 MM	NC : 0871, 0873, 0878, 0879	65,40	 0853 / 0854 0855 / 0856
CEI0855	<input type="checkbox"/>	CLASSIC VISCO CUSHION 430 X 430 MM	NC : 0871, 0873, 0878, 0879	65,40	
CEI0856	<input type="checkbox"/>	CLASSIC VISCO CUSHION 455 X 400 MM	NC : 0871, 0873, 0878, 0879	76,78	 0871
CEI0871	<input type="checkbox"/>	MATRX CONTOUR NG VISCO CUSHION	NC : 0873	76,78	 0873
CEI0873	<input type="checkbox"/>	MATRX FLO-TECH IMAGE CUSHION		246,45	
<b>SEAT CUSHION DEPTH</b>					
CEI0878	<input type="checkbox"/>	FOR 400 MM SEAT DEPTH		○	
CEI0879	<input type="checkbox"/>	FOR 450 MM SEAT DEPTH		○	 0882
<b>OTHER SEATING OPTIONS</b>					
CEI0852	<input type="checkbox"/>	SEAT RIGIDIZER	(Mandatory: Choose a seat cushion)	61,61	
CEI0882	<input type="checkbox"/>	LATERAL POSITIONING PADS (PAIR)		237,91	
CEI0905	<input type="checkbox"/>	EXCEPT FOR LAGUNA)	NC : 0906, 0907, 0940, 0945	60,10	
CEI0906	<input type="checkbox"/>	HEADREST BLACK PU TR26 (INCLUDING BACKBRACE EXCEPT FOR LAGUNA)	NC : 0907, 0940, 0945	199,05	 0905
CEI0907	<input type="checkbox"/>	HEADREST WITH CHEEK SUPPORT BLACK PU TR26 (INCLUDING BACKBRACE EXCEPT FOR LAGUNA)	NC : 0940, 0945	217,06	
CEI0930	<input type="checkbox"/>	ADJUSTABLE CALF STRAP		10,43	
CEI0935	<input type="checkbox"/>	LONGER FOOTREST TUBE (UL= 450-530 MM)	NC : 0936	17,06	
CEI0936	<input type="checkbox"/>	SHORTER FOOTREST SUPPORT (PAIR) (UL= 230-430 MM)		83,41	 0906      0907
CEI0940	<input type="checkbox"/>	BACKBRACE	NC : 0945	47,39	
CEI0945	<input type="checkbox"/>	FOLDABLE BACKBRACE	NC : 1451	105,21	 0945

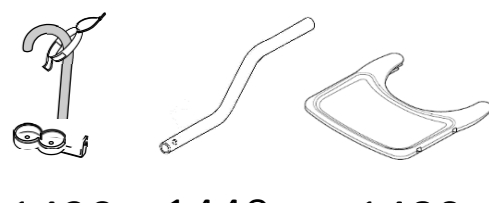
COLOURS						
CEI0961	<input type="checkbox"/>	SLATE GREY (RAL7024 FINE TEXTURE)		<input type="radio"/>	 0961 0964 0966 0974 0969 0980	
CEI0964	<input type="checkbox"/>	PEARL WHITE		<input type="radio"/>		
CEI0966	<input type="checkbox"/>	MATT BLACK		<input type="radio"/>		
CEI0969	<input type="checkbox"/>	RED MATT		<input type="radio"/>		
CEI0974	<input type="checkbox"/>	NAVY BLUE		<input type="radio"/>		
CEI0980	<input type="checkbox"/>	ANTHRACITE BLACK		<input type="radio"/>		
CEI0991	<input type="checkbox"/>	SPECIAL COLOUR	RAL :	On Request		
CASTER HOUSING TYPE						
CEI0995	<input type="checkbox"/>	STANDARD		<input type="radio"/>		
FRONT WHEELS						
CEI1005	<input type="checkbox"/>	200 X 32 MM (8" X 1.1/4") - BLACK PNEUMATIC TYRE		<input type="radio"/>	 1010 1050	
CEI1010	<input type="checkbox"/>	200 X 30 MM (8" X 1.1/4") - BLACK SOLID TYRE		<input type="radio"/>		
CEI1030	<input type="checkbox"/>	200 X 45 MM (8" X 2") - BLACK SOLID TYRE		<input type="radio"/>		
CEI1035	<input type="checkbox"/>	150 X 30 MM (6" X 1.1/4") - BLACK SOLID TYRE MEDIUM HARD		<input type="radio"/>		
CEI1050	<input type="checkbox"/>	150 X 30 MM (6" X 1.1/4") - BLACK SOLID TYRE		<input type="radio"/>		
REAR WHEELS						
REAR WHEEL SIZE						
CEI1068	<input type="checkbox"/>	24" - 600 mm		<input type="radio"/>	 Standard  1.3/8" 1.3/8" 1084 1082	
REAR WHEEL TYPE						
CEI1071	<input type="checkbox"/>	STANDARD (BLACK HUB, COLORLESS RIM & ZINC PLATED SPOKES)		<input type="radio"/>		
TYRE TYPE						
CEI1082	<input type="checkbox"/>	TYRES SOLID BLACK 35 MM (1"3/8)		<input type="radio"/>		
CEI1084	<input type="checkbox"/>	PNEUMATIC PROFILED BLACK 35 MM (1"3/8)		<input type="radio"/>		
REAR WHEELS POSITION						
CEI1200	<input type="checkbox"/>	PASSIVE REAR WHEELS POSITION - 25MM BACKWARDS/BACKREST CANE AXLE (12,5MM with Active Rear Wheel Support and Seat Depth 500MM)		<input type="radio"/>		
PUMP						
CEI1230	<input type="checkbox"/>	PUMP AND SUPPORT		10,43		
CHASSIS OPTIONS TYPE						
CEI1241	<input type="checkbox"/>	FRONT WHEELS EXTENSION (+ 50 MM OUTWARD)		<input type="radio"/>	 1241	
BRAKES TYPE						
CEI1270	<input type="checkbox"/>	PUSH TO LOCK BRAKES		<input type="radio"/>	 1270	
CEI1275	<input type="checkbox"/>	PULL TO LOCK BRAKES		<input type="radio"/>		
SAFETY OPTIONS TYPE						
CEI1345	<input type="checkbox"/>	TRANSPORTATION BRACKETS		24,64	 1345 1361 / 1362 1363 / 1364 1370 1375	
CEI1360	<input type="checkbox"/>	POSTURE BELT - PLASTIC BUCKLE	NC : 1361, 1362, 1363, 1364	31,28		
CEI1361	<input type="checkbox"/>	HIP BELT, 2-PT, CTR-PULL, PB - M X 460MM PADS, FLAT-MOUNT	NC : 1362, 1363, 1364	199,05		
CEI1362	<input type="checkbox"/>	HIP BELT, 2-PT, CTR-PULL, PB - L X 620MM PADS, FLAT-MOUNT	NC : 1363, 1364	206,64		
CEI1363	<input type="checkbox"/>	HIP BELT, 4-PT, CTR-PULL, PB - M X 460MM PADS, FLAT-MOUNT	NC : 1364	234,12		
CEI1364	<input type="checkbox"/>	HIP BELT, 4-PT, CTR-PULL, PB - L X 620MM PADS, FLAT-MOUNT		241,71		
CEI1370	<input type="checkbox"/>	REAR ANTI-TIPPERS PAIR	NC : 1375, 1440	79,62		
CEI1375	<input type="checkbox"/>	REAR ANTI-TIPPERS PAIR WITH TIPPING AID - (REA TYPE)	NC : 1440	127,96		
CEI1380	<input type="checkbox"/>	REFLECTORS KIT		38,86		
ATTENDANT OPTIONS TYPE						
CEI1430	<input type="checkbox"/>	CANE HOLDER		49,29	 1430 1440 1480	
CEI1440	<input type="checkbox"/>	TIPPING AID RH		28,44		
CEI1451	<input type="checkbox"/>	DRIP STAND SUPPORT WITH DRIPSTAND (WITH BACKBRACE 0940 ONLY)		101,42		

OTHERS OPTIONS			
CEI1480	<input type="checkbox"/>	ACRYLIC TRAY	72,83
<b>RAMPS</b>			
1440530	<input type="checkbox"/>	<b>Fiberglass Folding Mono Ramp</b> Folded dimensions: 2000 x 230 mm 16.3 kg - maximum capacity: 300 kg"	1 787,68
1654128	<input type="checkbox"/>	<b>Basic ramp 2 telescopic parts in aluminum and non-slip coating</b> - Folded dimensions: 1210 x 194 mm. 8.8 kg per pair - maximum capacity: 270 kg	402,84
1654129	<input type="checkbox"/>	<b>Quick2go Compact</b> 3-part aluminum telescopic ramp with non-slip coating Folded dimensions: 870 x 237 mm 13.6 kg per pair - maximum capacity: 260 kg	805,69
1654130	<input type="checkbox"/>	<b>Aluminium folding mono ramp</b> Folded dimensions: 1824 x 714 mm 13.9 kg - maximum capacity: 300 kg	426,54



1440530



1654128

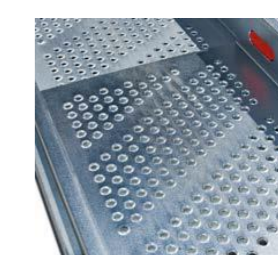

1654129

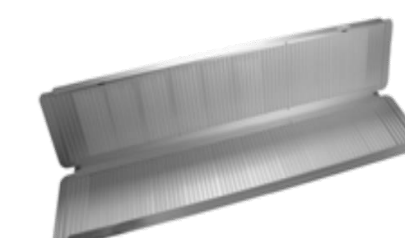

1654130