

# Invacare® TDX® SP2<sup>NB</sup> AA2 Ultra Low Maxx

Please contact Invacare EU Export Customer Services on :-  
 Tel : +33 247 626980 ; Email : serviceclient\_export@invacare.com  
 Or visit our website : www.invacare.eu.com



## Invacare® TDX® SP2<sup>NB</sup> AA2 Ultra Low Maxx Mid Power wheelchair 6 wheels



**Description:**  
 - Weight: from 154kg  
 - Max weight user: 136kg  
 - 2-year warranty excluding batteries and wearing parts.

Date :  
 User Name :  
 Customer Code :  
 Dealer stamp :



Customization Service Invacare Unique  
 Please indicate your quote number or special manufacturing number :

**Indicative Public Rate - Use the online configurator on Invacare Pro to generate quotes or orders free from incompatibilities.**

Please make your selection with a cross in the box     Standard configuration     Free of charge

CODE	DESCRIPTION	NC : Non Compatible NC : 9999 : non compatible avec la référence 9999	Euros
ARP0080	<input type="checkbox"/> Invacare® TDX® SP2 <sup>NB</sup> AA2 Ultra Low Maxx - Code LPPR 9125996 Power module: 90 A - Motors: 340W, 4 poles - Range: +/- 26 km (50Ah)		11 345,97

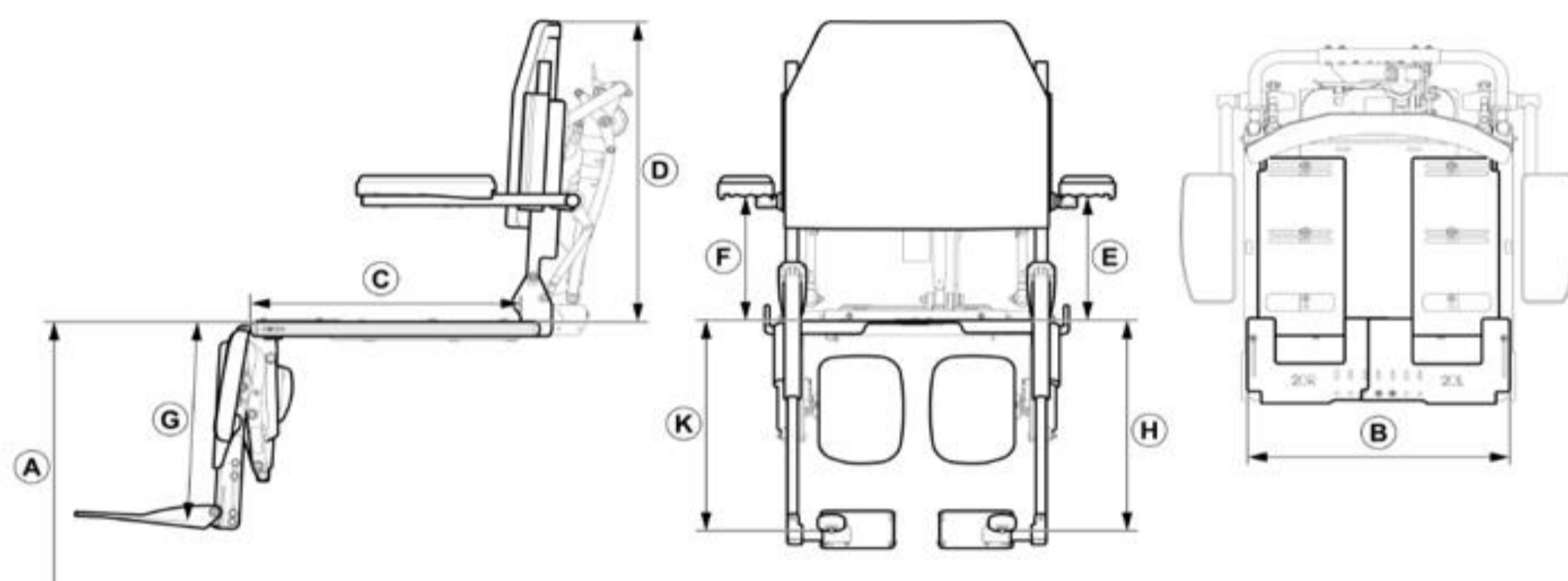

Customized settings:		Measured from:
<b>A</b> Seat Height		Seat plate to floor
<b>B</b> Seat Width		Front seat plate edge LH to seat plate edge RH
<b>C</b> Seat Depth		Front of seat plate (incl. curve) to bracket of backrest (lowest point)
<b>D</b> Finished Back Height		Seat plate to top of back
<b>E</b> Armrest Height LH		Seat plate to top of tube
<b>F</b> Armrest Height RH		Seat plate to top of tube
<b>G</b> Centre mount legrest		Top of seat plate to top of footplate, parallel to legrest / knee-to-heel length
<b>H</b> Side mount Legrest LH		Top of seat plate to top of footplate, parallel to legrest / knee-to-heel length
<b>K</b> Side mount Legrest RH		Top of seat plate to top of footplate, parallel to legrest / knee-to-heel length
<b>H</b> Pivot Plus Legrest LH		Top of seat plate to top of footplate, parallel to legrest / knee-to-heel length
<b>K</b> Pivot Plus Legrest RH		Top of seat plate to top of footplate, parallel to legrest / knee-to-heel length

### SEATING TYPE

ARP2020	<input type="checkbox"/> Ultra Low Maxx Powered Positioning System	<input type="radio"/>
---------	--	-----------------------

### POWERED POSITIONING OPTIONS

<b>SEAT TILT and combined SEAT TILT &amp; SEAT LIFTER</b>		
ARP2052	<input type="checkbox"/> Ultra Low Maxx CG Tilt (0 to 50°)	<input type="radio"/>
ARP2053	<input type="checkbox"/> Ultra Low Maxx CG Tilt (0 to 45°) combined w 300 mm Seat Lifter - Increased STF Height by 4 mm	NC : 2263, 2264 <input checked="" type="checkbox"/>

<b>A - SEAT HEIGHT SETTING</b>		<b>SEAT-TO-FLOOR HEIGHT MAY INCREASE DUE TO SETTINGS!</b>	
ARP0337	<input type="checkbox"/> 440 mm		<input checked="" type="checkbox"/>
ARP0331	<input type="checkbox"/> 460 mm		<input type="radio"/>
ARP0339	<input type="checkbox"/> 490 mm		<input type="radio"/>

ANTERIOR and POSTERIOR TILT OPTIONS				
ARP2057	<input type="checkbox"/>	Ultra Low Maxx CG Tilt Standard Mount - No anterior or posterior tilt		◆
ARP2054	<input type="checkbox"/>	Ultra Low Maxx CG tilt 5° Fixed Anterior Assist mount - Will reduce max tilt angle by 5°		447,39
ARP2055	<input type="checkbox"/>	Ultra Low Maxx CG tilt 10° Fixed Anterior Assist mount - Will reduce max tilt angle by 10°		530,81
ARP2056	<input type="checkbox"/>	Ultra Low Maxx CG tilt 5° Fixed Posterior-tilt Assist mount - Will increase max tilt angle by 5°		447,39
BACKREST RECLINER				
ARP2069	<input type="checkbox"/>	Fixed Angle Setting (NO POWERED RECLINE)	NC 2095, 2096, 2097, 2263, 2264, 2245	○
ARP2060	<input type="checkbox"/>	Powered Recline 90 to 170° , Standard Mount	NC 2307, 2510, 2511, 2512, 2513, 2514, 2515, 2516, 2540, 2541, 2542, 2543	◆
ARP2063	<input type="checkbox"/>	Powered Recline, 8° Precline mount, 82° to 162°	NC 2307, 2510, 2511, 2512, 2513, 2514, 2515, 2516, 2540, 2541, 2542, 2543	○
ARP2066	<input type="checkbox"/>	Powered Recline, 30° Precline mount, 60° to 140°	NC 2307, 2510, 2511, 2512, 2513, 2514, 2515, 2516, 2540, 2541, 2542, 2543	530,81
SEAT DIMENSIONS				
SEAT FRAME WIDTH RANGE				
ARP2021	<input type="checkbox"/>	405 mm - 505 mm (increments of 25 mm) / 16" - 20"		◆
ARU2003	<input type="checkbox"/>	480 mm - 555 mm (increments of 25 mm) / 19" - 22"		○
ARU2022	<input type="checkbox"/>	505 mm - 610 mm (increments of 25 mm) / 20" - 24"	NC : 2174, 2175	○
SEAT FRAME DEPTH RANGE				
ARP2008	<input type="checkbox"/>	405 mm - 505 mm (increments of 25 mm) / 16" - 20"		◆
ARP2024	<input type="checkbox"/>	480 mm - 580 mm (increments of 25 mm) / 19" - 23"		○
B - SEAT WIDTH SETTING FOR ADJUSTABLE SEAT FRAME				
ARP2025	<input type="checkbox"/>	405 mm	NC : 2022, 2041, 2042, 2701, 2703, 2705	○
ARP2026	<input type="checkbox"/>	430 mm	NC : 2022, 2041, 2142, 2701, 2703, 2705	○
ARP2027	<input type="checkbox"/>	455 mm	NC : 2022, 2701, 2703, 2705	○
ARP2028	<input type="checkbox"/>	480 mm	NC : 2022, 2702, 2704, 2706	○
ARP2029	<input type="checkbox"/>	505 mm	NC : 2702, 2704, 2706	○
ARP2030	<input type="checkbox"/>	530 mm	NC : 2021, 2034, 2035, 2036, 2174, 2175, 2702, 2704, 2706	○
ARP2031	<input type="checkbox"/>	555 mm	NC : 2021, 2034, 2035, 2036, 2174, 2175, 2702, 2704, 2706	○
ARP2032	<input type="checkbox"/>	580 mm	NC : 2021, 2034, 2035, 2036, 2174, 2175, 2147, 2702, 2704, 2706	○
ARP2033	<input type="checkbox"/>	610 mm	NC : 2021, 2034, 2035, 2036, 2174, 2175, 1404, 1405, 2147, 2702, 2704, 2706	○
C - SEAT DEPTH SETTING				
ARP2035	<input type="checkbox"/>	405 mm	NC : 2024, 0586, 0589, Bodypoint Belt	○
ARP2036	<input type="checkbox"/>	430 mm	NC : 2024	○
ARP2037	<input type="checkbox"/>	455 mm	NC : 2024	○
ARP2038	<input type="checkbox"/>	480 mm		○
ARP2039	<input type="checkbox"/>	505 mm	NC : 2023	○
ARP2040	<input type="checkbox"/>	530 mm	NC : 2023	○
ARP2041	<input type="checkbox"/>	555 mm	NC : 2023	○
ARP2042	<input type="checkbox"/>	580 mm	NC : 2023	○
SEAT CUSHION				
ARP2144	<input type="checkbox"/>	Matrx Vi Cushion [Mesh fabric]		293,84
ARP2145	<input type="checkbox"/>	Matrx Flo-Tech Lite black smooth cover, 75 mm thick - Up to 127 kg	NC : 2041, 2042, 2030, 2031, 2032, 2033	◆
ARP2146	<input type="checkbox"/>	Matrx Flo-tech Contour, black smooth cover, 100 mm thick - Up to 191 kg	NC : 2042	○
ARP2147	<input type="checkbox"/>	Matrx Libra Cushion, 90 mm thick - Standard: up to 136kg/ HD: up to 227kg - Extended lead time: + 4 days		340,28
BACK CANE HEIGHT - STRAIGHT OR ANGLED BACK CANES				
ARP2050	<input type="checkbox"/>	High Back, height 405 mm / 16" [Mesh fabric]		◆
ARP2051	<input type="checkbox"/>	High Back, height 455 mm / 18" [Mesh fabric]		○
ARP2320	<input type="checkbox"/>	High Back, height 505 mm / 20" [Mesh fabric]		○
ARP2550	<input type="checkbox"/>	Matrx Elite E2 Back, height 355mm / 14" / 16 - 18" wide	NC : 2030, 2031, 2032, 2033	○
ARP2551	<input type="checkbox"/>	Matrx Elite E2 Back, height 405 mm / 16"	NC : 2030, 2031, 2032, 2033	○
ARP2552	<input type="checkbox"/>	Matrx Elite E2 Back, height 455 mm / 18"	NC : 2030, 2031, 2032, 2033	○
ARP2553	<input type="checkbox"/>	Matrx Elite E2 Back, height 505 mm / 20"	NC : 2030, 2031, 2032, 2033	○
ARP2554	<input type="checkbox"/>	Matrx Elite HD Back, height 405 mm / 16"	NC : 2025, 2026, 2027, 2028, 2029	608,53
ARP2555	<input type="checkbox"/>	Matrx Elite HD Back, height 505 mm / 20"	NC : 2025, 2026, 2027, 2028, 2029	608,53
ARP2556	<input type="checkbox"/>	Matrx Elite TR Back, height 405 mm / 16" [Mesh fabric]	NC : 2030, 2031, 2032, 2033	608,53
ARP2557	<input type="checkbox"/>	Matrx Elite TR Back, height 455 mm / 18" [Mesh fabric]	NC : 2030, 2031, 2032, 2033	608,53
ARP2177	<input type="checkbox"/>	Matrx Elite TR Back, height 505 mm / 20" [Mesh fabric]	NC : 2025, 2026, 2027, 2028, 2029	608,53

ARP2563	<input type="checkbox"/>	Matrx Elite TR HD Back, height 505 mm / 20" [Mesh fabric]	NC : 2025, 2026, 2027, 2028, 2029	608,53
ARP2558	<input type="checkbox"/>	Matrx Elite Deep E2 Back, height 405 mm / 16" [Mesh fabric]	NC : 2030, 2031, 2032, 2033	608,53
ARP2559	<input type="checkbox"/>	Matrx Elite Deep E2 Back, height 455 mm / 18" [Mesh fabric]	NC : 2030, 2031, 2032, 2033	608,53
ARP2178	<input type="checkbox"/>	Matrx Elite Deep E2 Back, height 505 mm / 20" [Mesh fabric]	NC : 2030, 2031, 2032, 2033	608,53
ARP2174	<input type="checkbox"/>	Matrx PB Back, height 405 mm / 16" [Mesh fabric]		723,22
ARP2175	<input type="checkbox"/>	Matrx PB Back, height 505 mm / 20" [Mesh fabric]		723,22
ARP2560	<input type="checkbox"/>	Matrx PB Deep Back, height 405mm / 16"		723,22
ARP2561	<input type="checkbox"/>	Matrx PB Deep Back, height 505 mm / 20"		723,22
ARP2562	<input type="checkbox"/>	Matrx Elite Deep HD Back, height 505 mm / 20"		608,53
<b>D - FINISHED BACK HEIGHT</b>				
ARP2506	<input type="checkbox"/>	505 mm - unique with : 2550		○
ARP2501	<input type="checkbox"/>	535 mm - unique with : 2550		○
ARP2070	<input type="checkbox"/>	555 mm - unique with : 2050, 2551, 2554, 2556, 2558, 2174, 2560		○
ARP2071	<input type="checkbox"/>	585 mm - unique with : 2050, 2551, 2554, 2556, 2558, 2174, 2560		○
ARP2072	<input type="checkbox"/>	610 mm - unique with : 2051, 2552, 2557, 2559		○
ARP2073	<input type="checkbox"/>	635 mm - unique with : 2051, 2552, 2557, 2559		○
ARP2074	<input type="checkbox"/>	660 mm - unique with : 2320, 2553, 2555, 2177, 2563, 2178, 2175, 2561, 2562		○
ARP2502	<input type="checkbox"/>	685 mm - unique with : 2320, 2553, 2555, 2177, 2563, 2178, 2175, 2561, 2562		○
<b>ARMRESTS FOR ESR RECLINE SYSTEM</b>				
ARP2095	<input type="checkbox"/>	Cantilever Flip-Back Arm, width, height and angle adjustable, 240 - 330 mm (9.5" - 13")		◆
ARP2096	<input type="checkbox"/>	Cantilever Flip-Back Arm, width, height and angle adjustable, 340 - 405 mm (13.5 - 16")		○
ARP2097	<input type="checkbox"/>	Two-post Recline Arm, Flip Back, adjustable height 230 - 330 mm (9-13")		302,37
<b>ACCESSORIES FOR ARMRESTS</b>				
ARP2308	<input type="checkbox"/>	Spacers for armrest spacing reinforced with 25 mm per side		159,24
ARP2309	<input type="checkbox"/>	Spacers for armrest spacing reinforced with 25 mm per side		159,24
<b>ARM PAD Left Hand</b>				
ARP2012	<input type="checkbox"/>	Desk arm pad with startex cover visco foam [255mm]; 40 mm thick		◆
ARP2013	<input type="checkbox"/>	Full length arm pad with startex cover visco foam [355mm], 40 mm thick		○
ARP2014	<input type="checkbox"/>	Ergonomic arm trough; 30 mm thick	NC : 2347, 2348, 2349, 2350, 1404, 1405	163,98
<b>ARM PAD Right Hand</b>				
ARP2016	<input type="checkbox"/>	Desk arm pad with startex cover visco foam [255mm]; 40 mm thick		◆
ARP2017	<input type="checkbox"/>	Full length arm pad with startex cover visco foam [355mm]; 40 mm thick		○
ARP2018	<input type="checkbox"/>	Ergonomic arm trough, 30 mm thick	NC : 2351, 2352, 2353, 2354, 1404, 1405	163,98
<b>ARM PAD ACCESSORIES &amp; MOUNTING OPTIONS</b>				
Only in combination with arm trough / Always to be mounted on the opposite side of remote				
ARP2080	<input type="checkbox"/>	Flat Hand Pad Left		159,24
ARP2083	<input type="checkbox"/>	Flat Hand Pad Right		86,26
<b>MULTI-AXIS UPPER EXTREMITY SUPPORTS</b>				
ARP2082	<input type="checkbox"/>	Multi Axis Upper Extremity Support (MACES) Left, lowest armpad height will be increased by 43 mm		309,95
ARP2085	<input type="checkbox"/>	Multi Axis Upper Extremity Support (MACES) Right, lowest armpad height will be increased by 43 mm		309,95
<b>E - Height setting: ARMREST LH SEAT PAN TO TOP OF THE TUBE</b>				
Customized :				
<input type="checkbox"/>	290 mm			◆
<input type="checkbox"/>	230 mm   <input type="checkbox"/> 240 mm   <input type="checkbox"/> 250 mm   <input type="checkbox"/> 260 mm   <input type="checkbox"/> 270 mm			○
<input type="checkbox"/>	280 mm   <input type="checkbox"/> 300 mm   <input type="checkbox"/> 310 mm   <input type="checkbox"/> 320 mm   <input type="checkbox"/> 330 mm			○
<input type="checkbox"/>	340 mm   <input type="checkbox"/> 350 mm   <input type="checkbox"/> 360 mm   <input type="checkbox"/> 370 mm   <input type="checkbox"/> 380 mm			○
<input type="checkbox"/>	390 mm   <input type="checkbox"/> 405 mm			○

F - Height setting: ARMREST RH		SEAT PAN TO TOP OF THE TUBE	
Customized :			
<input type="checkbox"/>	290 mm		◆
<input type="checkbox"/>	230 mm   <input type="checkbox"/> 240 mm   <input type="checkbox"/> 250 mm   <input type="checkbox"/> 260 mm   <input type="checkbox"/> 270 mm		○
<input type="checkbox"/>	280 mm   <input type="checkbox"/> 300 mm   <input type="checkbox"/> 310 mm   <input type="checkbox"/> 320 mm   <input type="checkbox"/> 330 mm		○
<input type="checkbox"/>	340 mm   <input type="checkbox"/> 350 mm   <input type="checkbox"/> 360 mm   <input type="checkbox"/> 370 mm   <input type="checkbox"/> 380 mm		○
<input type="checkbox"/>	390 mm   <input type="checkbox"/> 405 mm		○
<b>ELBOW BLOCK LEFT: PADS</b>			
ARP2347	<input type="checkbox"/> Elbow Block XS (110 mm wide x 83 mm high)		296,68
ARP2348	<input type="checkbox"/> Elbow Block S (135 mm wide x 90 mm high)		296,68
ARP2349	<input type="checkbox"/> Elbow Block M (145 mm wide x 95 mm high)		296,68
ARP2350	<input type="checkbox"/> Elbow Block L (165 mm wide x 110 mm high)		296,68
<b>ELBOW BLOCK LEFT: MOUNTING HARDWARE</b>			
ARP2361	<input type="checkbox"/> Vertical 3"/ Horizontal 5"		○
ARP2362	<input type="checkbox"/> Vertical 3"/ Horizontal 7"		○
ARP2363	<input type="checkbox"/> Vertical 5"/ Horizontal 5"		○
ARP2364	<input type="checkbox"/> Vertical 5"/ Horizontal 7"		○
<b>ELBOW BLOCK RIGHT: PADS</b>			
ARP2351	<input type="checkbox"/> Elbow Block XS (110 mm wide x 83 mm high)		296,68
ARP2352	<input type="checkbox"/> Elbow Block S (135 mm wide x 90 mm high)		296,68
ARP2353	<input type="checkbox"/> Elbow Block M (145 mm wide x 95 mm high)		296,68
ARP2354	<input type="checkbox"/> Elbow Block L (165 mm wide x 110 mm high)		296,68
<b>ELBOW BLOCK RIGHT: MOUNTING HARDWARE</b>			
ARP2371	<input type="checkbox"/> Vertical 3"/ Horizontal 5"		○
ARP2372	<input type="checkbox"/> Vertical 3"/ Horizontal 7"		○
ARP2373	<input type="checkbox"/> Vertical 5"/ Horizontal 5"		○
ARP2374	<input type="checkbox"/> Vertical 5"/ Horizontal 7"		○
<b>HIP SUPPORTS</b>			
ARP2184	<input type="checkbox"/> Hip Support LH, Quick Release, pad size 140 x 100 mm	NC : Bodypoint Belt	290,05
ARP2114	<input type="checkbox"/> Hip Support LH, Quick Release, pad size 180 x 150 mm	NC : Bodypoint Belt	290,05
ARP2186	<input type="checkbox"/> Hip Support LH, Quick Release, pad size 230 x 100 mm	NC : Bodypoint Belt	290,05
ARP2188	<input type="checkbox"/> Hip Support LH, Quick Release, pad size 330 x 100 mm	NC : Bodypoint Belt	290,05
ARP2185	<input type="checkbox"/> Hip Support RH, Quick release, pad size 140 x 100 mm	NC : Bodypoint Belt	290,05
ARP2115	<input type="checkbox"/> Hip Support RH, Quick Release, pad size 180 x 150 mm	NC : Bodypoint Belt	290,05
ARP2187	<input type="checkbox"/> Hip Support RH, Quick release, pad size 230 x 100 mm	NC : Bodypoint Belt	290,05
ARP2189	<input type="checkbox"/> Hip Support RH, Quick Release, pad size 330 x 100 mm	NC : Bodypoint Belt	290,05
<b>MOUNTING HARDWARE FOR HIP SUPPORTS</b>			
ARP2164	<input type="checkbox"/> Mounting hardware for hip supports (155 mm high)		◆
ARP2165	<input type="checkbox"/> Mounting hardware for hip supports (206 mm high)		○
<b>HEADREST AND MOUNTING HARDWARE</b>			
ARP2092	<input type="checkbox"/> Onyx Auto Style Headrest		◆
ARP2324	<input type="checkbox"/> Elan Standard Pad 260 mm / 10" wide w/standard cover (ESP26)	Head Control or equivalent Headrest, provided independently from order	○
ARP2325	<input type="checkbox"/> Elan Occipital Pad 230 mm wide w/standard cover (EOP23)	Head Control or equivalent Headrest, provided independently from order	263,51
ARP1495	<input type="checkbox"/> Head Control or equivalent Headrest, provided independently from this order	NC : 2229	○
<b>LATERAL SUPPORTS</b>			
ARP2343	<input type="checkbox"/> Lateral Support Maxx Style Quick Release, pad size [110 mm wide x 83 mm high] LH		290,05
ARP2345	<input type="checkbox"/> Lateral Support Maxx Style Quick Release, pad size [135 mm wide x 90 mm high] LH		290,05
ARP2043	<input type="checkbox"/> Lateral Support Maxx Style Quick Release, pad size [145 mm wide x 95 mm high] LH		290,05
ARP2045	<input type="checkbox"/> Lateral Support Maxx Style Quick Release, pad size [165 mm wide x 110 mm high] LH		290,05
ARP2344	<input type="checkbox"/> Lateral Support Maxx Style Quick Release, pad size [110 mm wide x 83 mm high] RH		290,05
ARP2346	<input type="checkbox"/> Lateral Support Maxx Style Quick Release, pad size [135 mm wide x 90 mm high] RH		290,05
ARP2044	<input type="checkbox"/> Lateral Support Maxx Style Quick Release, pad size [145 mm wide x 95 mm high] RH		290,05
ARP2046	<input type="checkbox"/> Lateral Support Maxx Style Quick Release, pad size [165 mm wide x 110 mm high] RH		290,05
ARP2049	<input type="checkbox"/> Additional telescopic link for Maxx Style lateral support, 25 mm, Pair		107,11



2325

LEGRESTS / FOOTRESTS				
<b>CENTRE MOUNT LEGRESTS (Incl Calf pads)</b>				
ARP0586	<input type="checkbox"/>	Centre mount legrest, angle settable Length: 310 - 410 mm	NC : 0517	338,39
ARP0589	<input type="checkbox"/>	LNX Power centre mount legrest, length compensating; Length: 340 - 410 mm	NC : 2263, 2264	1 505,21
ARU0592	<input type="checkbox"/>	LNX Power centre mount legrest with telescoping foot platform (lowers to the ground); Length: 380 - 419 mm	NC : 2263, 2264, 2265	3 002,84
<b>FOOTPLATES / FOOT PLATFORM</b>				
ARP2365	<input type="checkbox"/>	Angle & width adjustable footplates S (127 W x 190 mm D / 5"x7.5")		○
ARP0559	<input type="checkbox"/>	Angle & width adjustable footplates M (140 W x 240 mm D / 5.5"x9.5")		◆
ARP0516	<input type="checkbox"/>	Angle & width adjustable footplates L (150 W x 290 mm D / 6"x11.5)		124,17
ARP0517	<input type="checkbox"/>	Angle adjustable foot platform M (305 W x 275 mm D / 12"x10.75")		124,17
<b>G - Height setting: Centre Mount Legrest, options 0586 &amp; 0589</b>				
			<b>SEAT PAN TO FOOTPLATE</b>	
Customized :				
<input type="checkbox"/> 375 mm				◆
<input type="checkbox"/> 310 mm   <input type="checkbox"/> 325 mm   <input type="checkbox"/> 335 mm   <input type="checkbox"/> 345 mm				○
<input type="checkbox"/> 355 mm   <input type="checkbox"/> 364 mm   <input type="checkbox"/> 385 mm   <input type="checkbox"/> 410 mm				○
<b>G- Height setting: Centre Mount w telescoping foot platform</b>				
			<b>SEAT PAN TO FOOTPLATE</b>	
Customized :				
<input type="checkbox"/> 380 mm   <input type="checkbox"/> 393 mm   <input type="checkbox"/> 406 mm   <input type="checkbox"/> 419 mm				○
<b>SIDE MOUNTED FRONT RIGGINGS FOR ULTRA LOW-MAXX</b>				
ARP0537	<input type="checkbox"/>	Hanger Vari A LH		◆
ARP0539	<input type="checkbox"/>	Hanger ADE 0° - 80° LH		343,13
ARP0547	<input type="checkbox"/>	Hanger Vari A RH		◆
ARP0549	<input type="checkbox"/>	Hanger ADE 0° - 80° RH		343,13
<b>H - Height setting: Vari Hanger LH</b>				
			<b>SEAT PAN TO FOOTPLATE</b>	
Customized :				
<input type="checkbox"/> 370 mm				◆
<input type="checkbox"/> 270 mm   <input type="checkbox"/> 280 mm   <input type="checkbox"/> 290 mm   <input type="checkbox"/> 300 mm				○
<input type="checkbox"/> 310 mm   <input type="checkbox"/> 320 mm   <input type="checkbox"/> 330 mm   <input type="checkbox"/> 340 mm				○
<input type="checkbox"/> 350 mm   <input type="checkbox"/> 360 mm   <input type="checkbox"/> 380 mm   <input type="checkbox"/> 390 mm				○
<input type="checkbox"/> 400 mm   <input type="checkbox"/> 410 mm   <input type="checkbox"/> 420 mm   <input type="checkbox"/> 430 mm				○
<b>H - Height setting: Vari Hanger LH</b>				
			<b>SEAT PAN TO FOOTPLATE</b>	
Customized :				
<input type="checkbox"/> 370 mm				◆
<input type="checkbox"/> 270 mm   <input type="checkbox"/> 280 mm   <input type="checkbox"/> 290 mm   <input type="checkbox"/> 300 mm				○
<input type="checkbox"/> 310 mm   <input type="checkbox"/> 320 mm   <input type="checkbox"/> 330 mm   <input type="checkbox"/> 340 mm				○
<input type="checkbox"/> 350 mm   <input type="checkbox"/> 360 mm   <input type="checkbox"/> 380 mm   <input type="checkbox"/> 390 mm				○
<input type="checkbox"/> 400 mm   <input type="checkbox"/> 410 mm   <input type="checkbox"/> 420 mm   <input type="checkbox"/> 430 mm				○
<b>INDIVIDUAL FOOTPLATE TYPE; LH</b>				
ARP0509	<input type="checkbox"/>	Angle Adjustable Footplate LH		◆
<b>INDIVIDUAL FOOTPLATE TYPE; RH</b>				
ARP0506	<input type="checkbox"/>	Angle Adjustable Footplate RH		◆
<b>LINX REMOTES</b>				
<b>LINX PRIMARY REMOTES with proportional Joystick + BRACKETS</b>				
ARP2203	<input type="checkbox"/>	Remote LiNX DLX-REM211 = Drive & Actuators 3 Drive functions and power module incl. 2 Actuators	NC : 2229, 2231, 2232, 2230, 2247, 2257, 2233, 2240, 2270, 2219, 2245	◆
ARP2204	<input type="checkbox"/>	Remote LiNX DLX-REM216 = Drive, Actuators & Lights 3 Drive functions and power module incl. 2 Actuators & Lights	NC : 2229, 2231, 2232, 2230, 2247, 2257, 2233, 2240, 2270, 2219, 2245	○
ARP2205	<input type="checkbox"/>	Rehab Remote LiNX, touch-screen user interface DLX-REM400 Configurable jack sockets		576,30
ARP2206	<input type="checkbox"/>	Rehab Remote LiNX without joystick for alternative access users DLX-REM500 Requires a user input/alternative joystick: 2231, 2232, 2229, 2230, 2247, 2257, 2233, 2240, 2243, 2255, 2256, 2271 or 2216	NC : 2270	1 713,74
<b>REM400 TOGGLE OPTION</b>				
ARP2270	<input type="checkbox"/>	Assignable Toggle Switch Module for REM400 (DLX-SW400TGL) as default set to left: ON/OFF, right speed dial		340,28

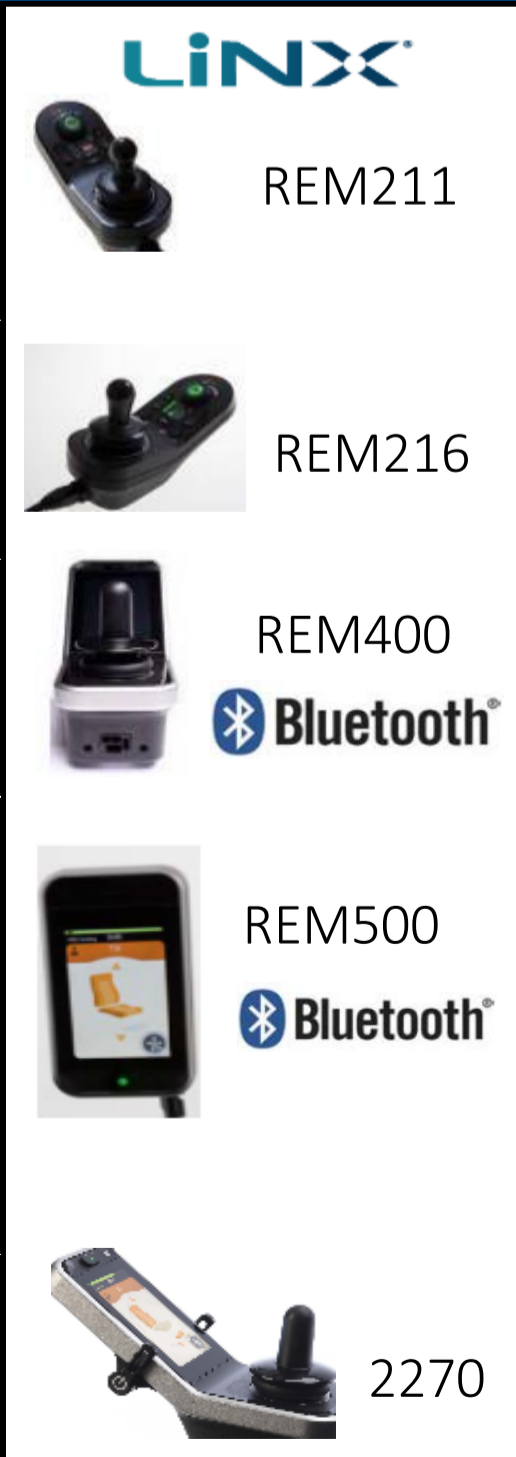

REMOTE MOUNTING POSITION				
ARP2107	<input type="checkbox"/>	Standard Bracket RH	NC : 1404	○
ARP2108	<input type="checkbox"/>	Standard Bracket LH	NC : 1405	○
ARP1707	<input type="checkbox"/>	Swing Away Bracket RH	NC : 1404	◆
ARP1708	<input type="checkbox"/>	Swing Away Bracket LH	NC : 1405	○
ARP1709	<input type="checkbox"/>	<b>Maxx resolve</b> , swing away in/out - RH	NC : 1404	○
ARP1710	<input type="checkbox"/>	<b>Maxx resolve</b> , swing away in/out - LH	NC : 1405	○
ARP2075	<input type="checkbox"/>	Swing Away + height / width adjust. Mount on RH for user, Quad link design	NC : 1415	233,18
ARP2076	<input type="checkbox"/>	Swing Away + height / width adjust. Mount on LH for user, Quad link design	NC : 1339	233,18
ARP2213	<input type="checkbox"/>	Centre Mount, swing-away to RH, Nucleus	NC : 1404, 1405	563,98
ARP2214	<input type="checkbox"/>	Centre Mount, swing-away to LH, Nucleus	NC : 1404, 1405	563,98
ARP2227	<input type="checkbox"/>	Bracket RH, mounted for Attendant	NC : 1221, 2219, 2245	161,14
ARP2228	<input type="checkbox"/>	Bracket LH, mounted for Attendant	NC : 1222, 2219, 2245	161,14
ARU2239	<input type="checkbox"/>	Montage personnalisé, merci de nous préciser votre demande :		On Demand
LiNX REM500 (DISPLAY ONLY) BRACKETS				
ARP2209	<input type="checkbox"/>	Swing away RH, multi-adjustable	NC : 1404	◆
ARP2210	<input type="checkbox"/>	Swing away LH, multi-adjustable	NC : 1405	○
PW-4005	<input type="checkbox"/>	Option 2209/2210 with fixing rod for REM500 extended by 200 mm		On Demand
ARP2213	<input type="checkbox"/>	Centre Mount, swing-away to RH, Nucleus	NC : 1404, 1405	685,31
ARP2214	<input type="checkbox"/>	Centre Mount, swing-away to LH, Nucleus	NC : 1404, 1405	685,31
ARU2239	<input type="checkbox"/>	Individual mounting option per request (Special) :		On Demand
DUAL CONTROL LiNX + BRACKETS				
ARP2219	<input type="checkbox"/>	Compact Dual Control LiNX (DLX-ACU200)	NC : 1221, 1222, 2227, 2228	1 091,94
ARP2245	<input type="checkbox"/>	Invacare LiNX IDC Dual control	NC : 1207, 1208, 2227, 2228, 2069	1 563,98
ARP1207	<input type="checkbox"/>	Standard Bracket RH		◆
ARP1208	<input type="checkbox"/>	Standard Bracket LH		○
ARP1221	<input type="checkbox"/>	Bracket RH, detachable		○
ARP1222	<input type="checkbox"/>	Bracket LH, detachable		○
If several joysticks (or Joystick + REM500) should be mounted on one Nucleus, please select special mounting option 2215!				
<a href="#">Mo-Vis special controls - refer to the order sheet</a>				
LiNX - COMPACT REMOTES & BRACKETS				
ARP2231	<input type="checkbox"/>	Proportional Compact Remote DLX-CR400		1 192,42
ARP2232	<input type="checkbox"/>	Proportional Compact Remote Low Force DLX-CR-400LF		1 311,85
ARP2207	<input type="checkbox"/>	RH Mount	NC : 1404	◆
ARP2208	<input type="checkbox"/>	LH Mount	NC : 1405	○
ARP2213	<input type="checkbox"/>	Centre Mount, swing-away to RH (Nucleus)	NC : 1404, 1405	717,54
ARP2214	<input type="checkbox"/>	Centre Mount, swing-away to LH (Nucleus)	NC : 1404, 1405	717,54
ARU2215	<input type="checkbox"/>	Individual mounting option per request (Special) :		On Demand
ALTERNATIVE JOYSTICKS + INPUTS + BRACKETS				
CHIN CONTROL + BRACKETS				
ARP2229	<input type="checkbox"/>	Proportional Chin Joystick (ASL138)	NC : 2230, 2247, 2233, 2257, 2240	3 011,37
ARP1289	<input type="checkbox"/>	Swing Away Bracket RH, side manual (ASL628)	Requires ELAN Headrest	◆
ARP1288	<input type="checkbox"/>	Swing Away Bracket LH, side manual (ASL628)	Requires ELAN Headrest	○
ARU1287	<input type="checkbox"/>	Swing Away Bracket RH, powered		1 445,50
ARU1286	<input type="checkbox"/>	Swing Away Bracket LH, powered		1 445,50
HEAD CONTROL ATOM Technology				
ARP2230	<input type="checkbox"/>	Head Control with ultrasonic proximity sensors (ATOM, ASL104) with standard wings M3	NC : 2233, 2092, 2324, 2325, 2257, 2240	5 648,34
ARP2247	<input type="checkbox"/>	Head Control with ultrasonic proximity sensors (PROTON, ASL104P) with PROTON wings	NC : 2233, 2092, 2324, 2325, 2257, 2240	5 648,34
FOUR-SWITCH PROXIMITY ARRAY (with ATOM Technology)				
ARP2257	<input type="checkbox"/>	Four-Switch Proximity Array (ASL106)	NC : 2233, 2240	6 129,89
ARP2275	<input type="checkbox"/>	Centre Mount, swing-away to RH, Nucleus	Incl. Eclipse Tray ASL619, 360x180 mm)	○
ARP2276	<input type="checkbox"/>	Centre Mount, swing-away to LH, Nucleus	Incl. Eclipse Tray ASL619, 360x180 mm)	○
ARU2215	<input type="checkbox"/>	Individual mounting option per request (Special) :		On Demand
WIRELESS ACCESSORIES FOR ATOM				
ARP2250	<input type="checkbox"/>	Wireless Mouse Emulator (ASL558)		1 506,16
LiNX - PROPORTIONAL REMOTES / INPUTS & BRACKETS				
ARP2233	<input type="checkbox"/>	MEC Proportional Joystick (Micro Extremity Control ASL130)	NC : 2240	3 366,82
ARP2235	<input type="checkbox"/>	Tray Mount RH (ASL603, 100x150 mm)		717,54
ARP2236	<input type="checkbox"/>	Tray Mount LH (ASL603, 100x150 mm)		717,54
ARP2213	<input type="checkbox"/>	Centre Mount, swing-away to RH, Nucleus	NC : 1404, 1405	○
ARP2214	<input type="checkbox"/>	Centre Mount, swing-away to LH, Nucleus	NC : 1404, 1405	○
ARP2241	<input type="checkbox"/>	Centre Mount, swing-away to RH, Nucleus	Incl. Tray ASL603, 100x150 mm	717,54
ARP2242	<input type="checkbox"/>	Centre Mount, swing-away to LH, Nucleus	Incl. Tray ASL603, 100x150 mm	717,54
ARU2215	<input type="checkbox"/>	Individual mounting option per request (Special) :		On Demand

**NEW**



2209  
2210



2219  
2245



2231  
2232



2229

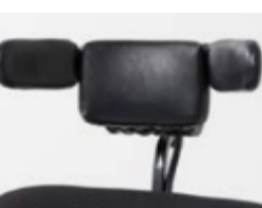

2230



2247



2257





















2250



2233

<b>Proportional reinforced joystick control</b>					
ARP2240	<input type="checkbox"/>	Proportional Heavy Duty Remote Joystick w mode switch (ASL133)		3 366,82	 2240
<b>PEDIATRIC COMPACT</b>					
ARP2243	<input type="checkbox"/>	Proportional Pediatric Compact (ASL132), includes Input Module		3 030,33	 2243
ARP2235	<input type="checkbox"/>	Tray Mount RH (ASL603, 100x150 mm)		○	
ARP2236	<input type="checkbox"/>	Tray Mount LH (ASL603, 100x150 mm)		○	
ARP2213	<input type="checkbox"/>	Centre Mount, swing-away to RH, Nucleus		○	
ARP2214	<input type="checkbox"/>	Centre Mount, swing-away to LH, Nucleus		○	
ARP2241	<input type="checkbox"/>	Centre Mount, swing-away to RH, Nucleus (incl. Tray ASL603, 100x150 mm)		717,54	
ARP2242	<input type="checkbox"/>	Centre Mount, swing-away to LH, Nucleus (incl. Tray ASL603, 100x150 mm)		717,54	
ARU2215	<input type="checkbox"/>	Individual mounting option per request (Special) :		On Demand	
<b>SIP'N PUFF HEAD CONTROL</b>					
ARP2255	<input type="checkbox"/>	Sip'n Puff Head Control (ASL109), (Combines simple sip and puff controls with head movements)	Includes Input Module and Lip Switch (ASL301 LIP)	6 731,75	 2255
<b>SIP'N PUFF CONTROL &amp; INPUT MODULE</b>					
ARP2256	<input type="checkbox"/>	Sip'n Puff Control	Includes Sip'n Puff kit, Lip Switch ASL301LIP, Input module	6 731,75	 2256
<b>LiNX INTERFACE OPTIONS (mounted &amp; connected)</b>					
ARP2271	<input type="checkbox"/>	Input Module DLX-IN500-A (sub D, Sip'n Puff)		507,11	
<b>ALTERNATIVE SEATING CONTROL</b>					
ARP2251	<input type="checkbox"/>	10-Way Switch DLX-SW10-A for direct Powered Seating Access		530,81	 2251
ARP2217	<input type="checkbox"/>	Bracket RH, mounted for user		○	
ARP2218	<input type="checkbox"/>	Bracket LH, mounted for user		○	
ARP2226	<input type="checkbox"/>	For Attendant, mounted on back shroud		○	
ARP2225	<input type="checkbox"/>	Without mounting		○	
<b>TOGGLES / BUTTONS</b>					
ARP2261	<input type="checkbox"/>	Stereo Toggle - direct control for tilt only		290,05	 2263
ARP2262	<input type="checkbox"/>	Stereo Button - direct control for tilt only		290,05	
ARP2263	<input type="checkbox"/>	Four-Way Toggle - direct control for tilt & recline		410,43	
ARP2264	<input type="checkbox"/>	Four-Way Button - direct control for tilt & recline		410,43	
ARP2207	<input type="checkbox"/>	RH Mount		○	
ARP2208	<input type="checkbox"/>	LH Mount		○	
ARP2225	<input type="checkbox"/>	Without mounting		○	
<b>LiNX ACCESSORIES</b>					
<b>USB CHARGER PORT</b>					
ARP2253	<input type="checkbox"/>	USB Charger Port DLX-USB02-A	NC : Bodypoint Belt	236,02	 2253
ARP2207	<input type="checkbox"/>	RH Mount		○	
ARP2208	<input type="checkbox"/>	LH Mount		○	
<b>REMOTE STOP SWITCH</b>					
ARP2258	<input type="checkbox"/>	Remote Stop Switch (ASL504)		831,28	 2258
<b>OUTPUT MODULE</b>					
ARP2272	<input type="checkbox"/>	LiNX Output Module (DLX-OUT500)		590,52	 2272
<b>FURTHER COMPONENTS / ACCESSORIES</b>					
ARP2300	<input type="checkbox"/>	To be enclosed only	Not mounted to the chair	○	
ARU2301	<input type="checkbox"/>	To be connected and programmed (Special)		On Demand	
<b>BUDDY BUTTONS - Accessory loom 2252 required, if no REM400 or REM500 is selected</b>					
ARP1685	<input type="checkbox"/>	Red Buddy Button		130,81	
ARP1686	<input type="checkbox"/>	Yellow Buddy Button		130,81	
ARP1687	<input type="checkbox"/>	Green Buddy Button		130,81	
ARP1690	<input type="checkbox"/>	Blue Buddy Button		130,81	
ARP1690	<input type="checkbox"/>	Blue Buddy Button		130,81	
<b>EGG SWITCH - Accessory loom 2252 required, if no REM400 or REM500 is selected</b>					
ARP2254	<input type="checkbox"/>	Egg Switch, black		103,32	
<b>PIKO BUTTONS - Accessory loom 2252 required, if no REM400 or REM500 is selected</b>					
ARP1711	<input type="checkbox"/>	Red Piko Button		130,81	
ARP1712	<input type="checkbox"/>	Yellow Piko Button		130,81	
ARP1713	<input type="checkbox"/>	Green Piko Button		130,81	
ARP1714	<input type="checkbox"/>	Orange Piko Button		130,81	
ARP1715	<input type="checkbox"/>	Blue Piko Button		130,81	
ARP1716	<input type="checkbox"/>	Black Piko Button		130,81	

BODYPOINT JOYSTICK KNOBS				2721 2722	
ARP2721	<input type="checkbox"/>	3 inch U-Shaped, Joystick Handle, Bodypoint PC101A	100,00	2723	
ARP2722	<input type="checkbox"/>	4 inch U-Shaped, Joystick Handle, Bodypoint PC102A	100,00	2724	
ARP2723	<input type="checkbox"/>	Domed Rubber, Joystick Handle, Bodypoint PC107A	100,00		
ARP2724	<input type="checkbox"/>	Mushroom Grooved, Joystick Handle, Bodypoint PC110A	100,00		
DRIVE UNIT DETAILS					
SHROUD COLOURS					
ARP2640	<input type="checkbox"/>	Obsidian black	○		2640
ARP2641	<input type="checkbox"/>	Ruby red	○		2641
ARP2642	<input type="checkbox"/>	Purple Passion	○		2642
ARP2643	<input type="checkbox"/>	Peacock blue	○		2643
ARP2644	<input type="checkbox"/>	Artic blue	○		2644
RIM INSERT COLOURS					
ARP2650	<input type="checkbox"/>	Obsidian black	○		2650
ARP2651	<input type="checkbox"/>	Ruby red	○		2651
ARP2652	<input type="checkbox"/>	Purple Passion	○		2652
ARP2653	<input type="checkbox"/>	Peacock blue	○		2653
ARP2654	<input type="checkbox"/>	Artic blue	○		2654
PERFORMANCE					
Forks					
ARP2631	<input type="checkbox"/>	Single sided fork (new) incl. black castor	399,05		
ARP2632	<input type="checkbox"/>	Double sided fork	◆		
CENTRE / DRIVE WHEELS					
ARP0704	<input type="checkbox"/>	14"x3" Black Tires, Pneumatic	◆		
ARP0705	<input type="checkbox"/>	14"x3" Black Tires, Solid tires	○		
ARP0706	<input type="checkbox"/>	14"x3" Black Tires Puncture Protect	○		
MOTOR TYPE / SPEED OPTIONS					
ARP1282	<input type="checkbox"/>	OPS Drive 6 km/h (4-pole)	◆		
ARP1283	<input type="checkbox"/>	OPS Drive 10 km/h (4-pole)	○		
BATTERY					
ARP1257	<input type="checkbox"/>	50 Ah Gel Batteries	◆		
CHARGER					
ARP1313	<input type="checkbox"/>	OptiCharge Charger 10A	◆		
ARP1313	<input type="checkbox"/>	Opti Charge Charger 10A (IP44) (UK Plug)	○		
G-Trac					
ARP1215	<input type="checkbox"/>	G-Trac Module	1 035,07		
OPTIONS					
LIGHT					
ARP1367	<input type="checkbox"/>	Light system with Indicators	627,49		
ARP1437	<input type="checkbox"/>	LED Light System	650,24		
ARP1254	<input type="checkbox"/>	Without Light system	◆		
TRANSPORTATION KIT					
ARP1450	<input type="checkbox"/>	Preparation for DAHL-Docking station <b>(Adequate headrest is compulsory)</b> Docking Station for car implementation, please order separately with DAHL Engineering	○		 
TIE-DOWNS					
ARP1494	<input type="checkbox"/>	4-Point tie-down (Tested version for using wheelchair as a vehicle seat according to ISO 7176-19) (Adequate headrest is compulsory)	◆		
ARP1401	<input type="checkbox"/>	6-Point tie-down (Tested version for using wheelchair as a vehicle seat according to ISO 7176-19) required for variants with combined Lift & Tilt module (Adequate headrest is compulsory)	○		
LAP BELT					
ARP2113	<input type="checkbox"/>	Lap belt with auto lock (flexible mount in side rails)	NC : Bodypoint Belt	◆	

BODYPOINT PELVIC BELTS - Includes mounting kit			
ARP2701	<input type="checkbox"/>	Evoflex Pelvic Stabilizer, Rehab Latch Size L	156,40
ARP2702	<input type="checkbox"/>	Evoflex Pelvic Stabilizer, Rehab Latch Size M	156,40
ARP2703	<input type="checkbox"/>	2-Point Hip Belt, Ctr-Pull, Push Butt, Cinch-Mount Size L	133,65
ARP2704	<input type="checkbox"/>	2-Point Hip Belt, Ctr-Pull, Push Butt, Cinch-Mount Size M	133,65
ARP2705	<input type="checkbox"/>	2-Point Hip Belt, Dual-Pull, Side-Release Butt. Cinch-Mount. Size L	116,59
ARP2706	<input type="checkbox"/>	2-Point Hip Belt, Dual-Pull, Side-Release Butt. Cinch-Mount. Size M	116,59
<b>REARVIEW MIRROR</b>			
ARU1415	<input type="checkbox"/>	RH Mirror	70,14
ARU1339	<input type="checkbox"/>	LH Mirror	70,14
<b>TRAY</b>			
ARP1404	<input type="checkbox"/>	Swing Away RH	478,67
ARP1405	<input type="checkbox"/>	Swing Away LH	478,67
<b>RAMPS</b>			
1440530	<input type="checkbox"/>	<b>Fiberglass Folding Mono Ramp</b> Folded dimensions: 2000 x 230 mm 16.3 kg - maximum capacity: 300 kg	1 787,68
1654130	<input type="checkbox"/>	<b>Aluminium folding mono ramp</b> Folded dimensions: 1824 x 714 mm 13.9 kg - maximum capacity: 300 kg	317,54



2701, 2702



2703, 2704



2705, 2706



1440530

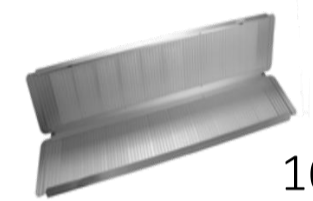

1654130