

Invacare[®] Action^{®4} NG HD

Please contact Invacare EU Export Customer Services on :-
 Tel : +33 247 626980 ; Email : serviceclient_export@invacare.com
 Or visit our website : www.invacare.eu.com



Invacare[®] Action^{®4} NG HD

Aluminum manual wheelchair folding by double brace



Date :

Purchase Order :

Customer Code :

Distributor Stamp:



Description:

- Weight: from 20.2 kg
- Maximum user weight: 160 kg
- 2-year warranty period excluding wear parts



Invacare Unique Customization Service

Please specify the quote or special production number:

Please make your selection with a cross in the box



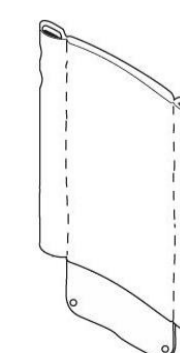

Standard feature

Free of charge option

CODE	DESCRIPTION	NC : Non Compatible NC : 9999 = not compatible with the reference 9999	Euros	
CKG0031	<input type="checkbox"/> Invacare [®] Action ^{®4} NG HD - Fixed Backrest		529,85	
CKG0041	<input type="checkbox"/> Invacare [®] Action ^{®4} NG HD - Reclining Backrest		766,82	
ALBER				
CKG0080	<input type="checkbox"/> BRACKET FOR VIAMOBIL V25	NC : 0110, 1196, 1200, 1240, 1246, 1252	313,74	
PROPULSION TYPE				
CKG0100	<input type="checkbox"/> Self Propulsion	NC : 0942		<input checked="" type="checkbox"/>
CKG0110	<input type="checkbox"/> Transit	NC : 0240, 0946, 0948, 1020, 1030, 1050, 1060, 1110, 1111, 1125		<input type="checkbox"/>
SEAT				
SEAT WIDTH				
CKG0170	<input type="checkbox"/> 505 MM Seat Width (Inc Back Brace)	NC : 0292		<input type="checkbox"/>
CKG0171	<input type="checkbox"/> 555 MM Seat Width (Inc reinforced seat upholstery & back brace)	NC : 0661, 0681, 1270		<input type="checkbox"/>
CKG0172	<input type="checkbox"/> 605 MM Seat Width (Inc reinforced seat upholstery and back brace)	NC : 0180, 0661, 0681, 1270		<input type="checkbox"/>
SEAT DEPTH				
CKG0180	<input type="checkbox"/> 400 mm	NC : 0292, 0702, 0703		<input type="checkbox"/>
CKG0190	<input type="checkbox"/> 450 mm	NC : 0701, 0703		<input checked="" type="checkbox"/>
CKG0195	<input type="checkbox"/> 500 mm	NC : 0295, 0661, 0681, 0701, 0702		<input type="checkbox"/>
CKG0200	<input type="checkbox"/> 400 TO 450 MM ADJUSTABLE SEAT DEPTH	NC : 0292, 0295, 0703		<input type="checkbox"/>
CKG0201	<input type="checkbox"/> 450 TO 500 MM ADJUSTABLE SEAT DEPTH	NC : 0295, 0661, 0681, 0701		<input type="checkbox"/>
	<input type="checkbox"/> 550 mm - with reinforced seat cover	NC : 0654, 0661, 0681, 1175		On Request
SEAT HEIGHT				
CKG0210	<input type="checkbox"/> 510 mm	NC : 0946		<input type="checkbox"/>
CKG0220	<input type="checkbox"/> 485 mm			<input checked="" type="checkbox"/>
CKG0230	<input type="checkbox"/> 460 mm			<input type="checkbox"/>
CKG0240	<input type="checkbox"/> 435 mm	NC : 0850, 0870, 0942		<input type="checkbox"/>
SEAT UPHOLSTERY TYPE				
CKG0290	<input type="checkbox"/> Nylon noir avec scratch			<input type="checkbox"/>
CKG0292	<input type="checkbox"/> NYLON WITH LOOP BANDS SEAT UPHOLSTERY	NC : 0654, 0661, 0681	167,77	
CKG0295	<input type="checkbox"/> PADDED NYLON SEAT UPHOLSTERY			<input checked="" type="checkbox"/>
BACKREST				
Backrest type - tensioner included - anti-tippers recommended with reclining backrest				
CKG0300	<input type="checkbox"/> FIXED 7° BACKREST - HEIGHT ADJUST 380 TO 460 MM (DELIVERED 380 MM)	NC : 0365, 0369, 0537, 0538, 0597, 0598, 0716, 0717, 0718, 1241		<input checked="" type="checkbox"/>
CKG0333	<input type="checkbox"/> RECLINING (GAS SPRING) 0/30° BACKREST INCL. BACKRACE & PASSIVE REAR WHEEL POS. ONLY - 3 HEIGHTS 390/410/430 MM (DELIVERED 430 MM)	NC : 0360, 1060		<input checked="" type="checkbox"/>

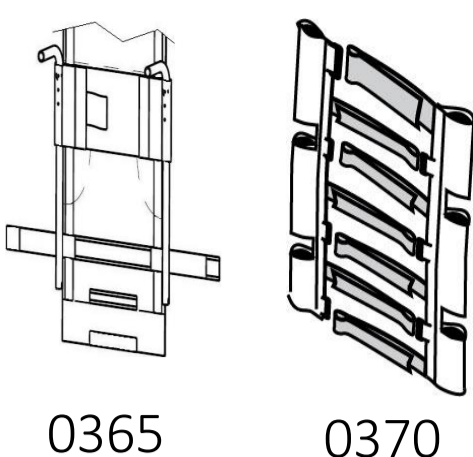

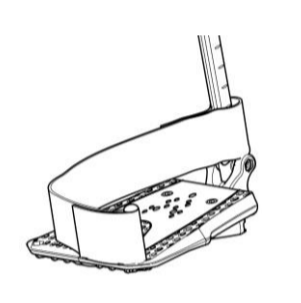
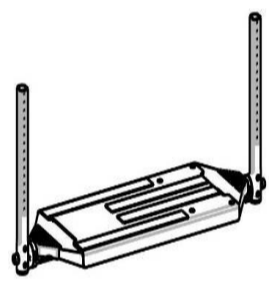
0360

BACKREST UPHOLSTERY TYPE					
CKG0360	<input type="checkbox"/>	STANDARD PADDED NYLON SLING TYPE	NC : 0721	◆	 0365 0370
CKG0365	<input type="checkbox"/>	LUMBAR SUPPORT (+1 STRAP) PADDED SHAPED COVER		○	
CKG0369	<input type="checkbox"/>	CONTOUR ADJUSTABLE (3+1 STRAPS) PADDED SHAPED COVER - INCLUDING BACK BRACE		33,08	
CKG0370	<input type="checkbox"/>	CONTOUR ADJUSTABLE (7+1 STRAPS) PADDED SHAPED COVER - INCLUDING BACK BRACE		138,39	
HANGERS/FOOTPLATES					
HANGERS RH TYPE					
CKG0390	<input type="checkbox"/>	80° STRAIGHT RH SWING IN/SWING OUT HANGER		◆	 0390 / 0440 0400 / 0450 0420 / 0470
CKG0400	<input type="checkbox"/>	ELEVATING LEGREST (0° TO 75°) RH SWING IN/SWING OUT HANGER (INCLUDING CALFPAD)	NC : 0480, 0491, 0760, 0770	73,82	
CKG0420	<input type="checkbox"/>	AMPUTEE LEGREST RH	NC : 0480, 0490, 0491, 0760	140,28	
HANGERS LH TYPE					
CKG0440	<input type="checkbox"/>	80° STRAIGHT LH SWING IN/SWING OUT HANGER		◆	 0420 / 0470 0490 / 0510 °
CKG0450	<input type="checkbox"/>	ELEVATING LEGREST (0° TO 75°) LH SWING IN/SWING OUT HANGER (INCLUDING CALFPAD)	NC : 0491, 0500, 0760, 0770	73,82	
CKG0470	<input type="checkbox"/>	AMPUTEE LEGREST LH	NC : 0491, 0500, 0510, 0760	140,28	
FOOTPLATES RH TYPE					
CKG0480	<input type="checkbox"/>	FLIP UP RH FOOTPLATE - INCLUDING ADJUSTABLE HEEL STRAP		◆	 0490 / 0510
CKG0490	<input type="checkbox"/>	FLIP UP DEPTH & ANGLE AJUSTABLE RH FOOTPLATE - INCLUDING ADJUSTABLE HEEL STRAP	NC : 0770	26,43	
CKG0491	<input type="checkbox"/>	FLIP UP ONE PIECE FOOTPLATE - DEPTH & ANGLE ADJUSTABLE	NC : 0500, 0510, 0770	234,12	
FOOTPLATES LH TYPE					
CKG0500	<input type="checkbox"/>	FLIP UP LH FOOTPLATE - INCLUDING ADJUSTABLE HEEL STRAP		◆	 0491
CKG0510	<input type="checkbox"/>	FLIP UP DEPTH & ANGLE AJUSTABLE LH FOOTPLATE - INCLUDING ADJUSTABLE HEEL STRAP	NC : 0770	26,43	
ARMRESTS					
ARMRESTS RH FORM IN BLACK COLOR					
CKG0520	<input type="checkbox"/>	REMOVABLE RH "RIO" (N°1) AUTOLOCK SAFETY DEVICE INCLUDED - DESK - ADJ. 200 TO 280 MM HEIGHT + SKIRTGUARD DEPTH & HEIGHT ADJ.	NC : 0593, 0595, 0596, 0597, 0598, 0603, 1270	◆	 0520 / 0580 0531 / 0581 0533 / 0593 0535 / 0595
CKG0531	<input type="checkbox"/>	RIO, REMOVABLE AND CONTINUOUSLY HEIGHT-ADJUSTABLE FROM 200 MM TO 280 MM - SHORT NARROW GUTTER (330 MM) WITHOUT ROTATION	NC : 0593, 0595, 0596, 0597, 0598, 0599, 0603, 1270	113,17	
CKG0533	<input type="checkbox"/>	REMOVABLE RH (N°4) AUTOLOCK SAFETY DEVICE INCLUDED - DESK - ADJ. IN HEIGHT (210-345 MM) + SKIRTGUARD HEIGHT ADJ.	NC : 0580, 0591, 0597, 0598, 0603, 1270	117,54	
CKG0535	<input type="checkbox"/>	REMOVABLE AND HEIGHT ADJUSTABLE - SHORT NARROW GUTTER (330 MM) WITHOUT ROTATION	NC : 0580, 0591, 0597, 0598, 0599, 0603, 1270	113,17	
CKG0536	<input type="checkbox"/>	REMOVABLE RH (N°4) AUTOLOCK SAFETY DEVICE INCLUDED - FULL LENGTH - ADJ. IN HEIGHT (210-345 MM) & DEPTH + SKIRTGUARD HEIGHT ADJ.	NC : 0580, 0591, 0597, 0598, 0603	117,54	
CKG0537	<input type="checkbox"/>	SWING AWAY DETACHABLE RH (N°2) - DESK	NC : 0580, 0591, 0593, 0595, 0596, 0603, 1270	○	
CKG0538	<input type="checkbox"/>	SWING AWAY DETACHABLE RH (N°2) - FULL LENGTH	NC : 0580, 0593, 0596	○	

ARMRESTS LH FORM IN BLACK COLOR				
CKG0580	<input type="checkbox"/>	REMOVABLE LH "RIO" (N°1) AUTOLOCK SAFETY DEVICE INCLUDED - DESK - ADJ. 200 TO 280 MM HEIGHT + SKIRTGUARD DEPTH & HEIGHT ADJ.	NC : 1270	◆
CKG0591	<input type="checkbox"/>	RIO, REMOVABLE AND CONTINUOUSLY HEIGHT-ADJUSTABLE FROM 200 MM TO 280 MM - SHORT NARROW GUTTER (330 MM) WITHOUT ROTATION	NC : 1270	113,17
CKG0593	<input type="checkbox"/>	REMOVABLE LH (N°4) AUTOLOCK SAFETY DEVICE INCLUDED - DESK - ADJ. IN HEIGHT (210-345 MM) + SKIRTGUARD HEIGHT ADJ.	NC : 1270	117,54
CKG0595	<input type="checkbox"/>	REMOVABLE AND HEIGHT ADJUSTABLE - SHORT NARROW GUTTER (330 MM) WITHOUT ROTATION	NC : 1270	113,17
CKG0596	<input type="checkbox"/>	REMOVABLE LH (N°4) AUTOLOCK SAFETY DEVICE INCLUDED - FULL LENGTH - ADJ. IN HEIGHT (210-345 MM) & DEPTH + SKIRTGUARD HEIGHT ADJ.		117,54
CKG0597	<input type="checkbox"/>	SWING AWAY DETACHABLE LH (N°2) - DESK	NC : 1270	○
CKG0598	<input type="checkbox"/>	SWING AWAY DETACHABLE LH (N°2) - FULL LENGTH		○
SEATING OPTIONS TYPE				
SEAT CUSHION TYPE				
CKG0654	<input type="checkbox"/>	BASIC 60 MM FOAM CUSHION - NYLON & ANTI-SLIP COVER	NC : 0661, 0681	33,08
CKG0661	<input type="checkbox"/>	MATRX FLO-TECH IMAGE CUSHION - DELIVERED WITH 1 PLATILON COVER + 1 BLACK SMOOTH COVER	NC : 0681, 0703	246,45
CKG0681	<input type="checkbox"/>	MATRX CONTOUR VISCO NG CUSHION - DELIVERED WITH 1 PLATILON COVER + 1 BLACK SMOOTH COVER	NC : 0703	76,78
SEAT CUSHION DEPTH				
CKG0701	<input type="checkbox"/>	Seat Depth 400 mm		○
CKG0702	<input type="checkbox"/>	Seat Depth 450 mm		○
CKG0703	<input type="checkbox"/>	Seat Depth 500 mm		○
OTHER SEATING OPTIONS				
CKG0716	<input type="checkbox"/>	NECKREST BLACK PU TR26 (INCLUDING BACKBRACE EXCEPT FOR LAGUNA)	NC : 0717, 0718	60,10
CKG0717	<input type="checkbox"/>	HEADREST BLACK PU TR26 (INCLUDING BACKBRACE EXCEPT FOR LAGUNA)	NC : 0718	199,05
CKG0718	<input type="checkbox"/>	HEADREST WITH CHEEK SUPPORT BLACK PU TR26 (INCLUDING BACKBRACE EXCEPT FOR LAGUNA)		217,06
CKG0721	<input type="checkbox"/>	LATERAL POSITIONING PADS (PAIR)		237,91
CKG0760	<input type="checkbox"/>	ADJUSTABLE CALF STRAP		10,43
CKG0770	<input type="checkbox"/>	LONGER FOOTREST TUBE (UL= 450-530 MM)		17,06
COLOURS				
CKG0801	<input type="checkbox"/>	SLATE GREY (RAL7024 FINE TEXTURE)		○
CKG0804	<input type="checkbox"/>	PEARL WHITE		○
CKG0806	<input type="checkbox"/>	ELECTRIC GREEN		54,03
CKG0807	<input type="checkbox"/>	MATT BLACK		○
CKG0811	<input type="checkbox"/>	RED MATT		○
CKG0815	<input type="checkbox"/>	WATER BLUE		54,03
CKG0816	<input type="checkbox"/>	NAVY BLUE		○
CKG0817	<input type="checkbox"/>	DARK PURPLE		54,03
CKG0820	<input type="checkbox"/>	ANTHRACITE BLACK		○
CKG0821	<input type="checkbox"/>	SPECIAL COLOUR		On Request
FRONT WHEELS				
CKG0850	<input type="checkbox"/>	200 X 30 MM (8" X 1.1/4") - BLACK SOLID TYRE		◆
CKG0870	<input type="checkbox"/>	200 X 45 MM (8" X 2") - BLACK SOLID TYRE		○



0537 / 0597

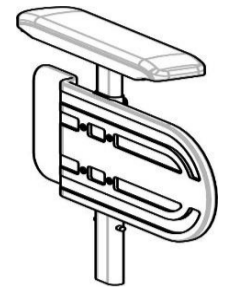

0533 / 0593

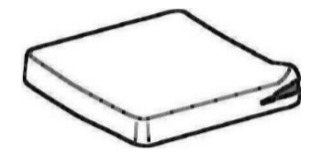

0654



0661



0681



0716

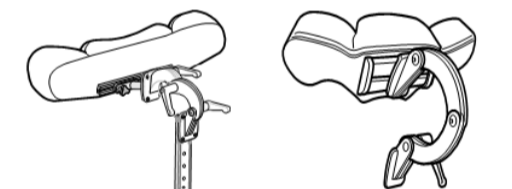

0717

0718



0721

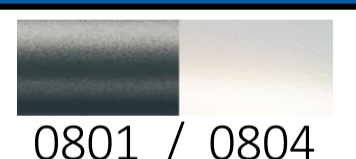

0801 / 0804



0806 / 0807

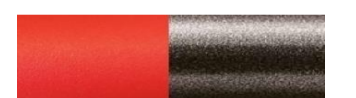

0811 / 0820



0816 / 0817





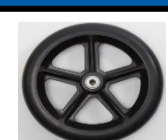

0815

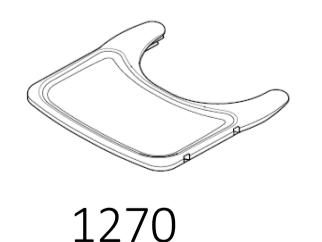
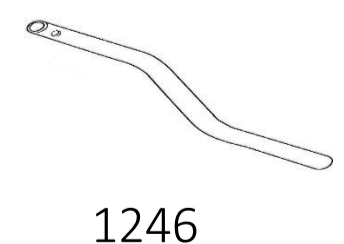
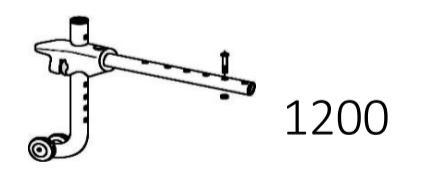
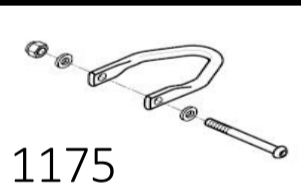
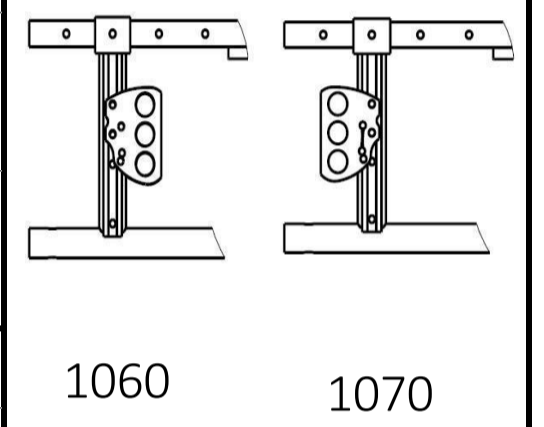
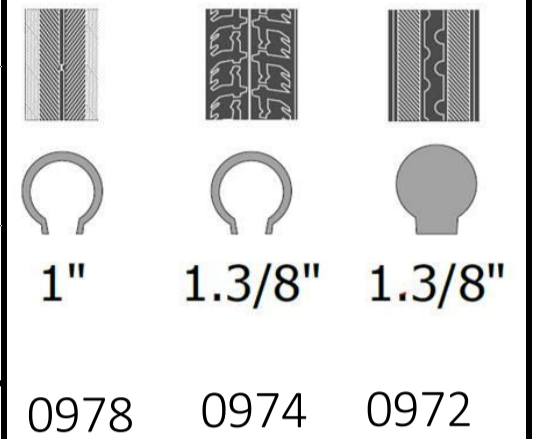

0850

REAR WHEELS				
REAR WHEEL SIZE				
CKG0942	<input type="checkbox"/>	12" - 305 mm	NC : 0962, 0974, 0978, 1020, 1030 1050, 1060, 1110, 1111, 1210, 1220	○
CKG0946	<input type="checkbox"/>	22" - 560 mm	NC : 1110	○
CKG0948	<input type="checkbox"/>	24" - 600 mm	NC : 1111	◆
REAR WHEELS TYPE				
CKG0962	<input type="checkbox"/>	REINFORCED (COLORLESS HUB, CLEAR ANODIZED RIM & STAINLESS STEEL SPOKES)	NC : 1130, 1040	◆
CKG0963	<input type="checkbox"/>	DRUM BRAKE (20/22/24" : COLORLESS HUB, CLEAR ANODIZED RIM & STAINLESS STEEL SPOKES / 12" : BLACK PLASTIC HUB & RIM)	NC : 1120, 1125	○
TYRE TYPE				
CKG0972	<input type="checkbox"/>	TYRES SOLID BLACK 35 MM (1"3/8)		◆
CKG0974	<input type="checkbox"/>	PNEUMATIC PROFILED BLACK 35 MM (1"3/8)		○
CKG0978	<input type="checkbox"/>	PNEUMATIC LOW PROFILE BLACK 25 MM (1")		○
HANDRIM TYPE				
CKG1020	<input type="checkbox"/>	ALUMINIUM PRE-ANODIZED HANDRIM		◆
CKG1030	<input type="checkbox"/>	HANDRIM COATED IN BLACK ANTI-SLIP PLASTIC	NC : 1130	127,01
REAR WHEELS AXLE TYPE				
CKG1040	<input type="checkbox"/>	FIXED AXLE		○
CKG1050	<input type="checkbox"/>	QUICK RELEASE AXLE		◆
REAR WHEELS POSITION				
CKG1060	<input type="checkbox"/>	STANDARD REAR WHEELS POSITION - 35 MM FRONTWARD/BACKREST CANE AXLE	NC : 1252	◆
CKG1070	<input type="checkbox"/>	PASSIVE REAR WHEELS POSITION - 35 MM BACKWARD/BACKREST CANE AXLE		○
PUMP				
CKG1090	<input type="checkbox"/>	PUMP AND SUPPORT		10,43
CHASSIS OPTIONS TYPE				
CKG1101	<input type="checkbox"/>	FRONT WHEELS EXTENSION (+ 50 MM OUTWARD)		○
CKG1110	<input type="checkbox"/>	SPOKE GUARDS PAIR 600 MM (24") BLACK		165,88
CKG1111	<input type="checkbox"/>	SPOKE GUARDS PAIR CLEAR		165,88
BRAKES TYPE				
CKG1120	<input type="checkbox"/>	PUSH TO LOCK BRAKES		◆
CKG1125	<input type="checkbox"/>	PULL TO LOCK BRAKES		○
CKG1130	<input type="checkbox"/>	ATTENDANT HUB BRAKES (INCLUDING PUSH TO LOCK BRAKES)		178,20
CKG1220	<input type="checkbox"/>	BRAKE EXTENSION PAIR		10,43
SAFETY OPTIONS TYPE				
CKG1175	<input type="checkbox"/>	TRANSPORTATION BRACKETS	NC : 1252	24,64
CKG1190	<input type="checkbox"/>	POSTURE BELT - PLASTIC BUCKLE	NC : 1189, 1192, 1193, 1194	31,28
CKG1189	<input type="checkbox"/>	HIP BELT, 2-PT, CTR-PULL, PB	NC : 1192, 1193, 1194	145,97
CKG1192	<input type="checkbox"/>	HIP BELT, 2-PT, CTR-PULL, PB	NC : 1193, 1194	152,61
CKG1193	<input type="checkbox"/>	HIP BELT, 4-PT, CTR-PULL, PB	NC : 1194	180,09
CKG1194	<input type="checkbox"/>	HIP BELT, 4-PT, CTR-PULL, PB		185,78
CKG1196	<input type="checkbox"/>	REAR ANTI-TIPPER (PAIR)	NC : 1200	79,62
CKG1200	<input type="checkbox"/>	REAR ANTI-TIPPERS PAIR WITH TIPPING AID	NC : 1246	125,12
CKG1210	<input type="checkbox"/>	REFLECTORS KIT		38,86
OTHERS OPTIONS				
CKG1240	<input type="checkbox"/>	CANE HOLDER		49,29
CKG1241	<input type="checkbox"/>	DRIP STAND SUPPORT WITH DRIP STAND (WITH BACKBRACE 0780 ONLY)		101,42
CKG1246	<input type="checkbox"/>	TIPPING AID (LH)		45,50
CKG1252	<input type="checkbox"/>	OXYGEN BOTTLE HOLDER (RH ONLY) - ANTI-TIPPERS RECOMMENDED		146,92
CKG1270	<input type="checkbox"/>	ACRYLIC TRAY		72,83

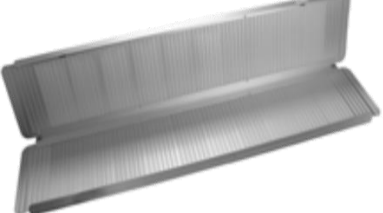

ACCESSORIES (delivered separately)					
AP1493219	<input type="checkbox"/>	GUTTER WITH INDEPENDENT SIDE ROTATION, ADJUSTABLE IN HEIGHT AND DEPTH, RIGHT	Only compatible with armrest 0533, 0536	113,17	 <p>1440530</p>  <p>1654128</p>  <p>1654129</p>  <p>1654130</p>
AP1493220	<input type="checkbox"/>	GUTTER WITH INDEPENDENT SIDE ROTATION, ADJUSTABLE IN HEIGHT AND DEPTH, LEFT	Only compatible with armrest 0593, 0596	113,17	
RAMPS					
1440530	<input type="checkbox"/>	Fiberglass Folding Mono Ramp Folded dimensions: 2000 x 230 mm 16.3 kg - maximum capacity: 300 kg		1 787,68	
1654128	<input type="checkbox"/>	Basic ramp 2 telescopic parts in aluminum and non-slip coating - Folded dimensions: 1210 x 194 mm. 8.8 kg per pair - maximum capacity: 270 kg		402,84	
1654129	<input type="checkbox"/>	Quick2go Compact 3-part aluminum telescopic ramp with non-slip coating Folded dimensions: 870 x 237 mm 13.6 kg per pair - maximum capacity: 260 kg		805,69	
1654130	<input type="checkbox"/>	Aluminium folding mono ramp Folded dimensions: 1824 x 714 mm 13.9 kg - maximum capacity: 300 kg		426,54	