

Invacare® Action³ NG Light

Please contact Invacare EU Export Customer Services on :-
 Tel : +33 247 626980 ; Email : serviceclient_export@invacare.com
 Or visit our website : www.invacare.eu.com



Invacare® Action³ NG Light

Folding aluminium manual wheelchair



Date :

Purchase Order :

Customer Code :

Distributor Stamp:



Description:
 - Weight: from 13 kg.
 - Maximum user weight: 125 kg.
 - 2-year warranty period excluding parts of wear
 - 1.2 kg lighter than an Action³NG:
 - Lightened fork supports
 - Active rear wheels as standard
 - Folding and angle-adjustable backrest at no extra charge



Invacare Unique Customization Service
 Please specify the quote or special production number:

Please make your selection with a cross in the box Standard feature Free of charge option

CODE	DESCRIPTION	NC : Non Compatible NC : 9999 = not compatible with the reference 9999	Euros	
CES0031	<input type="checkbox"/> Invacare® Action ³ NG RC - Fixed Backrest		529,85	
CES0036	<input type="checkbox"/> Invacare® Action ³ NG RC - Folding Backrest		572,18	
CES0041	<input type="checkbox"/> Invacare® Action ³ NG RC - Reclining Backrest		572,18	
ALBER				
CES0070	<input type="checkbox"/> BRACKET FOR TWION / E-MOTION M25 INCLUDING ALBER ANTI-TIPPER	NC : 0310, 0315, 0732, 0832, 1064, 1066, 1073, 1074, 1082, 1170, 1185, 1201, 1280, 1320, 1330, 1345, 1365, 1370, 1375, 1430, 1440	579,15	
CES0080	<input type="checkbox"/> BRACKET FOR VIAMOBIL V25	NC : 0300, 0310, 0315, 0455, 0460, 0451 à 0469, 0908, 1170, 1201, 1365, 1370, 1375, 1430, 1440	313,74	
CES0090	<input type="checkbox"/> BRACKET FOR VIAMOBIL ECO V14	NC : 0290, 0300, 0310, 0315, 0451 à 0469, 0905, 0906, 0907, 0908, 0945, 1185, 1201, 1365, 1370, 1375, 1430, 1440, 1451	414,25	
PROPULSION TYPE				
CES0100	<input type="checkbox"/> SELF PROPULSION			<input checked="" type="checkbox"/>
SEAT				
SEAT WIDTH				
CES0180	<input type="checkbox"/> 380 mm	NC : 0485, 0486, 0487, 0488, 0545+0595, 0852, 0855		<input type="checkbox"/>
CES0190	<input type="checkbox"/> 405 mm	NC : 0482, 0486, 0487, 0488, 0545+0595		<input type="checkbox"/>
CES0200	<input type="checkbox"/> 430 mm	NC : 0482, 0483, 0487, 0488, 0853		<input checked="" type="checkbox"/>
CES0210	<input type="checkbox"/> 455 mm	NC : 0482, 0483, 0484, 0488, 0853		<input type="checkbox"/>
CES0220	<input type="checkbox"/> 480 mm	NC : 0482, 0483, 0484, 0485, 0852, 0853, 0854		<input type="checkbox"/>
CES0230	<input type="checkbox"/> 505 mm	NC : 0482, 0483, 0484, 0485, 0486, 0852, 0853, 0854, 0855, 0856		<input type="checkbox"/>
On Demand	<input type="checkbox"/> 555 mm - with back tensioner and padded seat cover included - On request only Manufacturing time + 7 days	NC : 0431, 0432, 0330, 0340, 0849 + 0240, 0853 à 0873, 0852, 0945, 1480. Si hauteur de dossier 510 mm, toile de dossier nylon noir de série à la place de la toile de dossier bi-matière		On Demand
SEAT DEPTH				
CES0240	<input type="checkbox"/> 400 mm	NC : 0879		<input checked="" type="checkbox"/>
CES0250	<input type="checkbox"/> 450 mm	NC : 0853, 0878		<input type="checkbox"/>
CES0252	<input type="checkbox"/> 400 TO 450 MM ADJUSTABLE SEAT DEPTH	NC : 0330, 0350	30,33	

WITHOUT SUPPLEMENT !

SEAT HEIGHT				
CES0260	<input type="checkbox"/>	510 mm	NC : 0738, 0739, 0838, 0839, 1035, 1054, 1056 1066	○
CES0270	<input type="checkbox"/>	485 mm	NC : 1054	◆
CES0280	<input type="checkbox"/>	460 mm		○
CES0290	<input type="checkbox"/>	435 mm	NC : 0660/0670/0760/0770 + 24" wheels, 1005, 1010, 1030, 1056	○
CES0300	<input type="checkbox"/>	410 mm	NC : 24" wheels, 0935, 1005, 1010, 1030, 1056, 1365, 1370, 1440	○
CES0310	<input type="checkbox"/>	385 mm (only with CES1054 5" front wheels and 22" rear wheels)	NC : 0660, 0670, 0738, 0739, 0760, 0770, 0838, 0739, 0935, 1035, 1056, 1068, 1280, 1365, 1370, 1440	○
CES0315	<input type="checkbox"/>	360 mm (only with CES1054 5" front wheels and 20" rear wheels)	NC : 0600, 0620, 0660, 0670, 0738, 0739, 0760, 0770, 0838, 0839, 0935, 1280, 1035, 1056, 1066, 1068, 1365, 1375, 1440	145,02
SEAT UPHOLSTERY TYPE				
CES0330	<input type="checkbox"/>	NYLON WITHOUT LOOP BANDS SEAT UPHOLSTERY		◆
CES0340	<input type="checkbox"/>	NYLON WITH LOOP BANDS SEAT UPHOLSTERY		○
CES0350	<input type="checkbox"/>	PADDED NYLON SEAT UPHOLSTERY		30,33
BACKREST				
BACKREST TYPE				
CES0396	<input type="checkbox"/>	FIXED 7° BACKREST - HEIGHT ADJUST 380 TO 460 MM (DELIVERED 380 MM)	NC : 0451 à 0469, 0474, 0477, 0478, 0481, 0905, 0906, 0907, 0908, 0940, 1451	295,73
CES0410	<input type="checkbox"/>	FIXED 7° BACKREST - 2 HEIGHTS 400/430 MM (DELIV. 430 MM)	NC : 0471, 0477, 0945	◆
CES0420	<input type="checkbox"/>	FIXED 7° BACKREST - 510 MM HEIGHT	NC : 0471, 0477, 0945	33,18
CES0431	<input type="checkbox"/>	ANGLE ADJUSTABLE AND FOLD DOWN (-15° to + 15°) FIXED 7°, HEIGHT 350MM / 14" WITH FIXED SHORT PUSHHANDLES	NC : 0471, 0474, 0478, 0481, 0882, 0905, 0906, 0907, 0940, 1280, 1345, 1451	○
CES0432	<input type="checkbox"/>	ANGLE ADJUSTABLE AND FOLD DOWN (-15° to + 15°) FIXED 7°, HEIGHT 425MM / 17" WITH FIXED LONG PUSHHANDLES	NC : 0471, 0474, 0478, 0481, 0882	○
CES0435	<input type="checkbox"/>	RECLINING (RATCHET) 0/30° BACKREST INCL. BACKRACE & PASSIVE REAR WHEEL POS. ONLY	NC : 0471, 0477, 0738, 0739, 0940, 0945, 1185, 1190	◆
CES0445	<input type="checkbox"/>	RECLINING (GAS SPRING) 0/30° BACKREST INCL. BACKRACE & PASSIVE REAR WHEEL POS. ONLY	NC : 0471, 0477, 0738, 0739, 0940, 0945, 1185, 1190	○
CES0450	<input type="checkbox"/>	RECLINING (GAS SPRING) 0/30° BACKREST INCL. BACKRACE & PASSIVE REAR WHEEL POS. ONLY	NC : 0471, 0477, 0738, 0739, 0940, 0945, 1185, 1190	33,18
CES0455	<input type="checkbox"/>	FOLDING 7° BACKREST	NC : 0451 à 0454, 0458 à 0467, 0471, 0477, 0945	◆
CES0460	<input type="checkbox"/>	FOLDING 7° BACKREST	NC : 0451 à 0454, 0458 à 0467, 0471, 0477, 0481, 0945	33,18
MATRX BACK (LOSS OF APPROX 20 MM SEAT DEPTH WITH RECLINING GAS SPRING BACKREST)				
CES0451	<input type="checkbox"/>	MATRX ELITE E2 BACK WITH HARDWARE - 160 MM BACK HEIGHT - CURVED 80 MM - MINI FASTENERS	NC : 0471, 0474, 0477, 0478, 0481, 0882, 0940, 0945	717,54
CES0452	<input type="checkbox"/>	MATRX ELITE E2 BACK WITH HARDWARE - 210 MM BACK HEIGHT - CURVED 80 MM - MINI FASTENERS	NC : 0471, 0474, 0477, 0478, 0481, 0882, 0940, 0945	717,54
CES0453	<input type="checkbox"/>	MATRX ELITE E2 BACK WITH HARDWARE - 260 MM BACK HEIGHT - CURVED 80 MM - MINI FASTENERS	NC : 0471, 0474, 0477, 0478, 0481, 0882, 0940, 0945	717,54
CES0454	<input type="checkbox"/>	MATRX ELITE E2 BACK WITH HARDWARE - 310 MM BACK HEIGHT - CURVED 80 MM - MINI FASTENERS	NC : 0471, 0474, 0477, 0478, 0481, 0882, 0940, 0945	717,54
CES0456	<input type="checkbox"/>	MATRX ELITE E2 BACK WITH HARDWARE - 360 MM BACK HEIGHT - CURVED 80 MM - MINI FASTENERS	NC : 0471, 0474, 0477, 0478, 0481, 0882, 0940, 0945	717,54
CES0461	<input type="checkbox"/>	MATRX ELITE E2 BACK WITH HARDWARE - 410 MM BACK HEIGHT - CURVED 80 MM - MINI FASTENERS	NC : 0471, 0474, 0477, 0478, 0481, 0882, 0940, 0945	717,54
CES0462	<input type="checkbox"/>	MATRX ELITE E2 BACK WITH HARDWARE - 460 MM BACK HEIGHT - CURVED 80 MM - STANDARD FASTENERS	NC : 0471, 0474, 0477, 0478, 0481, 0882, 0940, 0945	717,54
CES0457	<input type="checkbox"/>	MATRX ELITE E2 BACK WITH HARDWARE - 510 MM BACK HEIGHT - CURVED 80 MM - STANDARD FASTENERS	NC : 0471, 0474, 0477, 0478, 0481, 0882, 0940, 0945	717,54
CES0458	<input type="checkbox"/>	MATRX ELITE DEEP E2 BACK WITH HARDWARE - 160 MM BACK HEIGHT - CURVED 160 MM - MINI FASTENERS	NC : 0471, 0474, 0477, 0478, 0481, 0882, 0940, 0945	717,54
CES0459	<input type="checkbox"/>	MATRX ELITE DEEP E2 BACK WITH HARDWARE - 210 MM BACK HEIGHT - CURVED 160 MM - MINI FASTENERS	NC : 0471, 0474, 0477, 0478, 0481, 0882, 0940, 0945	717,54
CES0466	<input type="checkbox"/>	MATRX ELITE DEEP E2 BACK WITH HARDWARE - 260 MM BACK HEIGHT - CURVED 160 MM - MINI FASTENERS	NC : 0471, 0474, 0477, 0478, 0481, 0882, 0940, 0945	717,54
CES0467	<input type="checkbox"/>	MATRX ELITE DEEP E2 BACK WITH HARDWARE - 310 MM BACK HEIGHT - CURVED 160 MM - MINI FASTENERS	NC : 0471, 0474, 0477, 0478, 0481, 0882, 0940, 0945	717,54



0396



0435

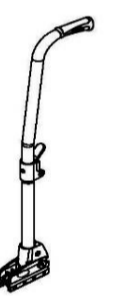

0455 / 0460

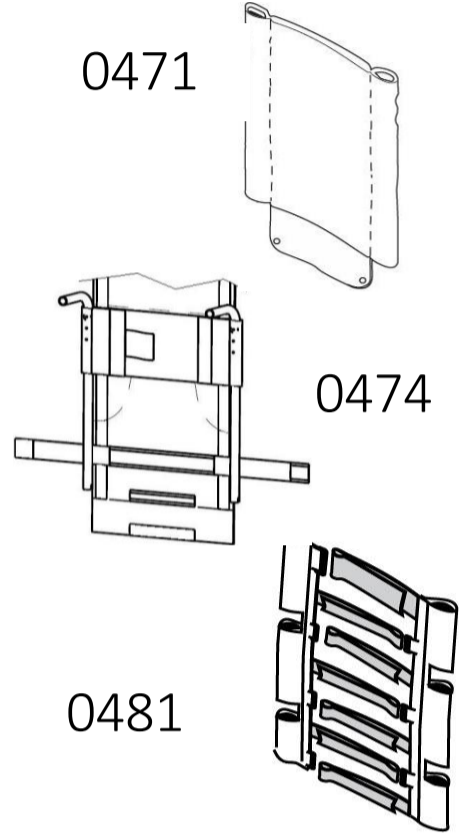
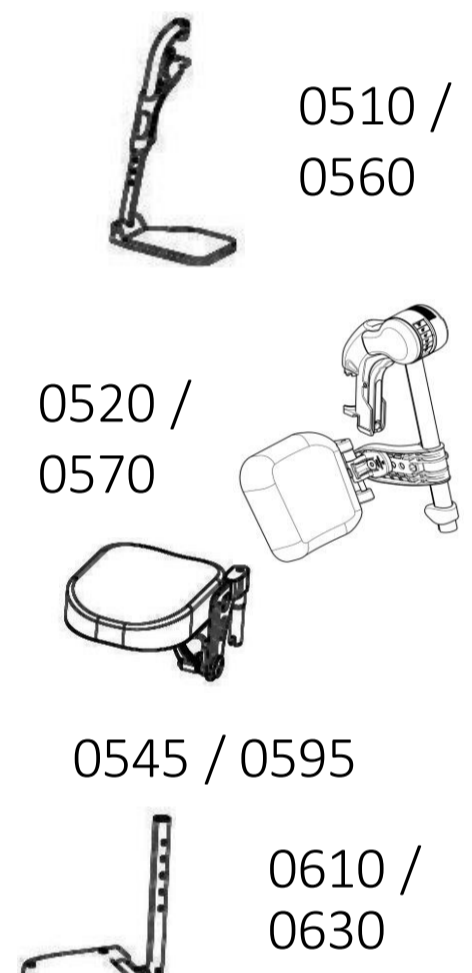

*Matrx Elite E2 /
Elite Deep E2*

CES0468	<input type="checkbox"/>	MATRX ELITE DEEP E2 BACK WITH HARDWARE - 360 MM BACK HEIGHT - CURVED 160 MM - MINI FASTENERS	NC : 0471, 0474, 0477, 0478, 0481, 0882, 0940, 0945	717,54	Fixation standard 
CES0463	<input type="checkbox"/>	MATRX ELITE DEEP E2 BACK WITH HARDWARE - 410 MM BACK HEIGHT - CURVED 160 MM - MINI FASTENERS	NC : 0471, 0474, 0477, 0478, 0481, 0882, 0940, 0945	717,54	
CES0464	<input type="checkbox"/>	MATRX ELITE DEEP E2 BACK WITH HARDWARE - 460 MM BACK HEIGHT - CURVED 160 MM - STANDARD FASTENERS	NC : 0471, 0474, 0477, 0478, 0481, 0882, 0940, 0945	717,54	
CES0469	<input type="checkbox"/>	MATRX ELITE DEEP E2 BACK WITH HARDWARE - 510 MM BACK HEIGHT - CURVED 160 MM - STANDARD FASTENERS	NC : 0471, 0474, 0477, 0478, 0481, 0882, 0940, 0945	717,54	
MATRX BACKRESTS WIDTH CHOICE - SEE TABLE AT END					
CES0482	<input type="checkbox"/>	360 MM - INDICATIVE BUST WIDTH : 265 MM		○	
CES0483	<input type="checkbox"/>	380 MM - INDICATIVE BUST WIDTH : 290 MM		○	
CES0484	<input type="checkbox"/>	410 MM - INDICATIVE BUST WIDTH : 315 MM		○	
CES0485	<input type="checkbox"/>	430 MM - INDICATIVE BUST WIDTH : 340 MM		○	
CES0486	<input type="checkbox"/>	460 MM - INDICATIVE BUST WIDTH : 370 MM		○	
CES0487	<input type="checkbox"/>	480 MM - INDICATIVE BUST WIDTH : 390 MM		○	
CES0488	<input type="checkbox"/>	510 MM - INDICATIVE BUST WIDTH : 420 MM		○	
BACKREST UPHOLSTERY TYPE					
CES0471	<input type="checkbox"/>	STANDARD NYLON SLING TYPE (JEMIMA)	NC : 0882, 0905, 0906, 0907	○	 <p>0471</p> <p>0474</p> <p>0481</p>
CES0474	<input type="checkbox"/>	LUMBAR SUPPORT (+1 STRAP) BI MATERIAL PADDED COVER INCL. BACK POCKET		◆	
CES0477	<input type="checkbox"/>	CONTOUR ADJUSTABLE (3+1 STRAPS) BI MATERIAL PADDED COVER INCL. BACK POCKET		○	
CES0478	<input type="checkbox"/>	CONTOUR ADJUSTABLE (3+1 STRAPS) BI MATERIAL PADDED COVER INCL. BACK POCKET	NC : 0940, 0945	○	
CES0481	<input type="checkbox"/>	CONTOUR ADJUSTABLE (7+1 STRAPS) BI MATERIAL PADDED COVER INCL. BACK POCKET	NC : 0940, 0945	189,57	
HANGERS/FOOTPLATES					
HANGERS RH TYPE					
CES0510	<input type="checkbox"/>	80° STRAIGHT RH SWING IN/SWING OUT HANGER		◆	 <p>0510 / 0560</p> <p>0520 / 0570</p> <p>0545 / 0595</p> <p>0610 / 0630</p>
CES0520	<input type="checkbox"/>	ELEVATING LEGREST (0° TO 75°) RH SWING IN/SWING OUT HANGER (INCLUDING CALFPAD)	NC : 0611, 0930, 0935, 0936	73,82	
CES0545	<input type="checkbox"/>	AMPUTEE LEGREST RH	NC : 0600, 0610, 0611, 0930, 0936	140,28	
HANGERS LH TYPE					
CES0560	<input type="checkbox"/>	80° STRAIGHT LH SWING IN/SWING OUT HANGER		◆	
CES0570	<input type="checkbox"/>	ELEVATING LEGREST (0° TO 75°) LH SWING IN/SWING OUT HANGER (INCLUDING CALFPAD)	NC : 0611, 0930, 0935, 0936	73,82	
CES0595	<input type="checkbox"/>	AMPUTEE LEGREST LH	NC : 0611, 0620, 0630, 0930, 0936	140,28	
FOOTPLATES RH TYPE					
CES0600	<input type="checkbox"/>	FLIP UP RH FOOTPLATE - (INCLUDING HEEL STRAP)		◆	
CES0610	<input type="checkbox"/>	FLIP UP DEPTH & ANGLE AJUSTABLE RH FOOTPLATE - (INCLUDING HEEL STRAP)		26,43	
CES0611	<input type="checkbox"/>	FLIP UP ONE PIECE FOOTPLATE - DEPTH & ANGLE ADJUSTABLE	NC : 0620, 0630, 0935, 0936	234,12	
FOOTPLATES LH TYPE					
CES0620	<input type="checkbox"/>	FLIP UP LH FOOTPLATE - (INCLUDING HEEL STRAP)		◆	
CES0630	<input type="checkbox"/>	FLIP UP DEPTH & ANGLE AJUSTABLE LH FOOTPLATE - (INCLUDING HEEL STRAP)		26,43	

ARMRESTS
ARMRESTS RH FORM IN BLACK COLOR

CES0640	<input type="checkbox"/>	REMOVABLE RH (N°1) AUTOLOCK SAFETY DEVICE INCLUDED - DESK	NC : 0760, 0770, 0772, 0780, 0790, 0795, 0796, 0798, 0838, 0839, 1480, 1483	◆
CES0650	<input type="checkbox"/>	REMOVABLE RH (N°1) AUTOLOCK SAFETY DEVICE INCLUDED - FULL LENGTH	NC : 0760, 0770, 0772, 0780, 0790, 0795, 0796, 0798, 0838, 0839	24,64
CES0656	<input type="checkbox"/>	REMOVABLE AND CONTINUOUSLY HEIGHT-ADJUSTABLE FROM 200 MM TO 280 MM - SHORT NARROW GUTTER (330 MM) WITHOUT ROTATION	NC : 0760, 0770, 0772, 0780, 0790, 0795, 0796, 0798, 0838, 1480	113,17
CES0660	<input type="checkbox"/>	REMOVABLE RH (N°1) "RIO" Special Only For Denmark AUTOLOCK SAFETY DEVICE INCLUDED -	NC : 0740, 0750, 0756, 0772, 0780, 0790, 0795, 0796, 0798, 0838, 0839, 1480, 1483	○
CES0670	<input type="checkbox"/>	SWING AWAY DETACHABLE RH (N°2) - FULL LENGTH	NC : 0740, 0750, 0756, 0780, 0790, 0795, 0796, 0798, 0838, 0839	24,64
CES0672	<input type="checkbox"/>	LIFTABLE AND REMOVABLE, HEIGHT-ADJUSTABLE FROM 170 TO 295 MM - SHORT (330 MM) NON-ROTATING NARROW TROUGH WITH CLOTHES GUARD AND ERGONOMIC SUPPORT HANDLE	NC : 0740, 0750, 0760, 0770, 0795, 0796, 0798, 0838, 1480	113,17
CES0680	<input type="checkbox"/>	SWING AWAY DETACHABLE RH (N°3) - DESK	NC : 0740, 0750, 0756, 0760, 0770, 0795, 0796, 0838, 0839, 1480, 1483	117,54
CES0690	<input type="checkbox"/>	SWING AWAY DETACHABLE RH (N°3) - FULL LENGTH	NC : 0740, 0750, 0756, 0760, 0770, 0795, 0796, 0838, 0839, 1483	140,28
CES0695	<input type="checkbox"/>	REMOVABLE RH (N°4) AUTOLOCK SAFETY DEVICE INCLUDED - DESK	NC : 0740, 0750, 0756, 0760, 0770, 0772, 0780, 0790, 0838, 0839, 1185, 1480, 1483	117,54
CES0696	<input type="checkbox"/>	REMOVABLE RH (N°4) AUTOLOCK SAFETY DEVICE INCLUDED - FULL LENGTH	NC : 0740, 0750, 0756, 0760, 0770, 0772, 0780, 0790, 0838, 0839, 1185, 1483	140,28
CES0698	<input type="checkbox"/>	REMOVABLE AND HEIGHT ADJUSTABLE - SHORT NARROW GUTTER (330 MM) WITHOUT ROTATION	NC : 0740, 0750, 0756, 0760, 0770, 0772, 0780, 0790, 0838, 1185, 1480	113,17
CES0732	<input type="checkbox"/>	REMOVABLE RH (N°4) AUTOLOCK SAFETY DEVICE INCLUDED - ARMPAD HEMI BLACK PU TR26	NC : 0838, 0839, 1185, 1480, 1483	113,17
CES0738	<input type="checkbox"/>	REMOVABLE MUDGUARD RH (N°6) (CUSHION IS RECOMMENDED FOR SEAT HEIGHT 410 & 435 MM) -	NC : 0740, 0750, 0760, 0770, 0780, 0790, 0795, 0796, 0832, 0839, 1064, 1066, 1200, 1201, 1480, 1483	60,66
CES0739	<input type="checkbox"/>	TUBULAR ARMREST RH, SWING AWAY PADDED TUBE WITH REMOVABLE MUDGUARD RH (N°6) (CUSHION IS RECOMMENDED FOR SEAT HEIGHT 410 & 435 MM) -	NC : 0740, 0750, 0760, 0770, 0780, 0790, 0795, 0796, 0832, 0838, 1064, 1066, 1200, 1201, 1345, 1430, 1365, 1480, 1483	129,86

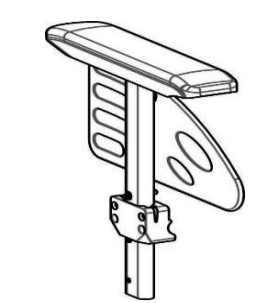

0640 / 0740



0656 / 0756



0660 / 0760



0680 / 0780

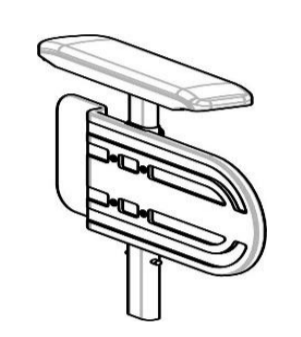

0695 / 0795



0698 / 0798

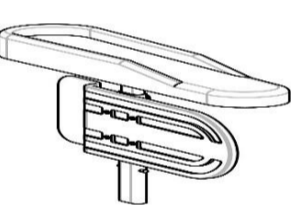

0732 / 0832

ARMRESTS LH FORM IN BLACK COLOR

CES0740	<input type="checkbox"/>	REMOVABLE LH (N°1) AUTOLOCK SAFETY DEVICE INCLUDED - DESK	NC : 1480, 1484	◆
CES0750	<input type="checkbox"/>	REMOVABLE LH (N°1) AUTOLOCK SAFETY DEVICE INCLUDED - FULL LENGTH		24,64
CES0756	<input type="checkbox"/>	REMOVABLE AND CONTINUOUSLY HEIGHT-ADJUSTABLE FROM 200 MM TO 280 MM - SHORT NARROW GUTTER (330 MM) WITHOUT ROTATION		113,17
CES0760	<input type="checkbox"/>	SWING AWAY DETACHABLE LH (N°2) - DESK	NC : 1480, 1484	○
CES0770	<input type="checkbox"/>	SWING AWAY DETACHABLE LH (N°2) - FULL LENGTH		24,64
CES0772	<input type="checkbox"/>	LIFTABLE AND REMOVABLE, HEIGHT-ADJUSTABLE FROM 170 TO 295 MM - SHORT (330 MM) NON-ROTATING NARROW TROUGH WITH CLOTHES GUARD AND ERGONOMIC SUPPORT HANDLE	NC : 1480	113,17
CES0780	<input type="checkbox"/>	SWING AWAY DETACHABLE LH (N°3) - DESK	NC : 1480, 1484	117,54
CES0790	<input type="checkbox"/>	SWING AWAY DETACHABLE LH (N°3) - FULL LENGTH	NC : 1484	140,28
CES0795	<input type="checkbox"/>	REMOVABLE LH (N°4) AUTOLOCK SAFETY DEVICE INCLUDED - DESK	NC : 1185	113,17
CES0796	<input type="checkbox"/>	REMOVABLE LH (N°4) AUTOLOCK SAFETY DEVICE INCLUDED - FULL LENGTH	NC : 1185, 1480, 1484	117,54
CES0798	<input type="checkbox"/>	REMOVABLE AND HEIGHT ADJUSTABLE - SHORT NARROW GUTTER (330 MM) WITHOUT ROTATION	NC : 1185, 1484	140,28
CES0832	<input type="checkbox"/>	REMOVABLE LH (N°4) AUTOLOCK SAFETY DEVICE INCLUDED - ARMPAD HEMI BLACK PU TR26	NC : 1185, 1480, 1484	113,17
CES0838	<input type="checkbox"/>	REMOVABLE MUDGUARD LH (N°6) (CUSHION IS RECOMMENDED FOR SEAT HEIGHT 410 & 435 MM) -	NC : 1064, 1066, 1484	60,66
CES0839	<input type="checkbox"/>	TUBULAR ARMREST LH, SWING AWAY PADDED TUBE WITH REMOVABLE MUDGUARD LH (N°6) (CUSHION IS RECOMMENDED FOR SEAT HEIGHT 410 & 435 MM)	NC : 1064, 1066, 1200, 1201, 1345, 1365, 1430, 1480, 1484	129,86

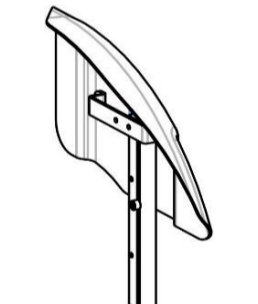

0738 / 0838

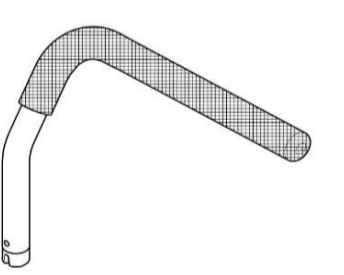

0739 / 0839

SEAT CUSHION TYPE					
Cushion					
CES0849	<input type="checkbox"/>	BASIC 60 MM FOAM CUSHION - NYLON & ANTI-SLIP COVER	NC : 0853, 0854, 0855, 0856, 0871, 0873	33,08	
CES0853	<input type="checkbox"/>	CLASSIC VISCO CUSHION 375X 400 MM -	NC : 0871, 0873, 0878, 0879	76,78	0849
CES0854	<input type="checkbox"/>	CLASSIC VISCO CUSHION 405 X 400 MM -	NC : 0871, 0873, 0878, 0879	65,40	
CES0855	<input type="checkbox"/>	CLASSIC VISCO CUSHION 430 X 430 MM -	NC : 0871, 0873, 0878, 0879	65,40	0853 / 0854 0855 / 0856
CES0856	<input type="checkbox"/>	CLASSIC VISCO CUSHION 455 X 400 MM -	NC : 0871, 0873, 0878, 0879	76,78	
CES0871	<input type="checkbox"/>	MATRX CONTOUR NG VISCO CUSHION	NC : 0873	76,78	0871
CES0873	<input type="checkbox"/>	MATRX FLO-TECH IMAGE CUSHION		246,45	
CES0876	<input type="checkbox"/>	MATRX LIBRA CUSHION		293,84	0873 0876
SEAT CUSHION DEPTH					
CES0878	<input type="checkbox"/>	FOR 400 MM SEAT DEPTH		<input type="radio"/>	
CES0879	<input type="checkbox"/>	FOR 450 MM SEAT DEPTH		<input type="radio"/>	
OTHER SEATING OPTIONS					
CES0852	<input type="checkbox"/>	SEAT RIGIDIZER	(Mandatory: Choose a seat cushion)	61,61	0882
CES0882	<input type="checkbox"/>	LATERAL POSITIONING PADS (PAIR)		237,91	
CES0905	<input type="checkbox"/>	NECKREST BLACK PU TR26 (INCLUDING BACKBRACE EXCEPT FOR LAGUNA)	NC : 0906, 0907, 0908, 0940, 0945	60,10	0905
CES0906	<input type="checkbox"/>	HEADREST BLACK PU TR26 (INCLUDING BACKBRACE EXCEPT FOR LAGUNA)	NC : 0907, 0908, 0940, 0945	199,05	
CES0907	<input type="checkbox"/>	HEADREST WITH CHEEK SUPPORT BLACK PU TR26 (INCLUDING BACKBRACE EXCEPT FOR LAGUNA) -	NC : 0908, 0940, 0945	217,06	0906 0907
CES0908	<input type="checkbox"/>	MATRX SOFT PAD HEADREST (SOFT PAD 250MM) WITH FIXED HARDWARE		441,71	
CES0930	<input type="checkbox"/>	ADJUSTABLE CALF STRAP		10,43	0908
CES0935	<input type="checkbox"/>	LONGER FOOTREST TUBE (UL= 450-530 MM)	NC : 0936	17,06	
CES0936	<input type="checkbox"/>	SHORTER FOOTREST SUPPORT (PAIR) (UL= 230-430 MM)		83,41	
CES0940	<input type="checkbox"/>	BACKBRACE	NC : 0945	47,39	
CES0945	<input type="checkbox"/>	FOLDABLE BACKBRACE	NC : 1451	105,21	0945
COLOURS					
CES0961	<input type="checkbox"/>	SLATE GREY (RAL7024 FINE TEXTURE)		<input type="radio"/>	
CES0964	<input type="checkbox"/>	PEARL WHITE		<input type="radio"/>	
CES0965	<input type="checkbox"/>	ELECTRIC GREEN		54,03	0961 / 0964 / 0965 / 0966
CES0966	<input type="checkbox"/>	MATT BLACK		<input type="radio"/>	
CES0969	<input type="checkbox"/>	RED MATT		<input type="radio"/>	
CES0972	<input type="checkbox"/>	WATER BLUE		54,03	0974 / 0976 / 0969 / 0980
CES0974	<input type="checkbox"/>	NAVY BLUE		<input type="radio"/>	
CES0976	<input type="checkbox"/>	DARK PURPLE		54,03	
CES0980	<input type="checkbox"/>	ANTHRACITE BLACK		<input type="radio"/>	
CES0991	<input type="checkbox"/>	SPECIAL COLOUR		On Request	0972
CASTER HOUSING TYPE					
CES0996	<input type="checkbox"/>	LIGHT WEIGHT		<input type="radio"/>	
FRONT WHEELS					
CES1005	<input type="checkbox"/>	200 X 32 MM (8" X 1.1/4") - BLACK PNEUMATIC TYRE		<input type="radio"/>	
CES1010	<input type="checkbox"/>	200 X 30 MM (8" X 1.1/4") - BLACK SOLID TYRE		<input type="radio"/>	1010 1050
CES1030	<input type="checkbox"/>	200 X 45 MM (8" X 2") - BLACK SOLID TYRE		<input type="radio"/>	
CES1035	<input type="checkbox"/>	150 X 30 MM (6" X 1.1/4") - BLACK SOLID TYRE MEDIUM HARD		<input type="radio"/>	
CES1050	<input type="checkbox"/>	150 X 30 MM (6" X 1.1/4") - BLACK SOLID TYRE		<input type="radio"/>	
CES1054	<input type="checkbox"/>	125 X 30 MM (5" X 1") - BLACK SOLID TYRE		<input type="radio"/>	
CES1056	<input type="checkbox"/>	140 X 40 MM (5" 1/2 X 1" 3/4) - BLACK SOLID TYRE MEDIUM HARD		<input type="radio"/>	

REAR WHEELS				
REAR WHEEL SIZE				
CES1064	<input type="checkbox"/>	20" - 515 mm	NC : 1071, 1073, 1074, 1076, 1088, 1092 1170, 1260, 1280	○
CES1066	<input type="checkbox"/>	22" - 560 mm	NC : 1074, 1092, 1260	○
CES1068	<input type="checkbox"/>	24" - 600 mm	NC : 1261	◆
REAR WHEEL TYPE				
CES1071	<input type="checkbox"/>	STANDARD (BLACK HUB, COLORLESS RIM & ZINC PLATTED SPOKES)	NC : 1092, 1140, 1170, 1280	○
CES1072	<input type="checkbox"/>	REINFORCED (COLORLESS HUB, CLEAR ANODIZED RIM & STAINLESS STEEL SPOKES)	NC : 1092, 1280	○
CES1073	<input type="checkbox"/>	DRUM BRAKE (20/22/24" : COLORLESS HUB, CLEAR ANODIZED RIM & STAINLESS STEEL SPOKES / 12" : BLACK PLASTIC HUB & RIM)	NC : 1092, 1270, 1275, 1320, 1330	○
CES1074	<input type="checkbox"/>	COMPOSITE (BLACK PLASTIC HUB & RIM)	NC : 1088, 1092, 1260, 1261, 1280	○
CES1076	<input type="checkbox"/>	LIGHTWEIGHT (BLACK HUB & RIM, 24 BLACK RADIAL SPOKES)	NC : 1170, 1201, 1230, 1260, 1261, 1280	◆
TYRE TYPE				
CES1082	<input type="checkbox"/>	TYRES SOLID BLACK 35 MM (1"3/8)		◆
CES1084	<input type="checkbox"/>	PNEUMATIC PROFILED BLACK 35 MM (1"3/8)		○
CES1088	<input type="checkbox"/>	PNEUMATIC LOW PROFILE BLACK 25 MM (1")		○
CES1092	<input type="checkbox"/>	PNEUMATIC MAXXIS ALPHA PROTECT 25 MM (1")	83,41	○
HANDRIM TYPE				
CES1140	<input type="checkbox"/>	ALUMINIUM PRE-ANODIZED HANDRIM		◆
CES1150	<input type="checkbox"/>	HANDRIM COATED IN BLACK ANTI-SLIP PLASTIC	127,01	○
REAR WHEELS AXLE TYPE				
CES1170	<input type="checkbox"/>	FIXED AXLE	NC : 1185, 1280, 1365	○
CES1180	<input type="checkbox"/>	QUICK RELEASE AXLE		◆
REAR WHEELS POSITION				
CES1185	<input type="checkbox"/>	ACTIVE REAR WHEELS POSITION - 37,5MM FRONTWARDS/BACKREST CANE AXLE (with Active Rear Wheel Support)	NC : 1320, 1330, 1345, 1365	148,82
CES1190	<input type="checkbox"/>	STANDARD REAR WHEELS POSITION - 25MM FRONTWARDS/BACKREST CANE AXLE (12,5MM with Active Rear Wheel Support and Seat Depth 500MM)		◆
CES1200	<input type="checkbox"/>	PASSIVE REAR WHEELS POSITION - 25MM BACKWARDS/BACKREST CANE AXLE (12,5MM with Active Rear Wheel Support and Seat Depth 500MM)		○
CES1201	<input type="checkbox"/>	DUAL AMPUTEE REAR WHEELS POSITIONS - TRANSIT=75MM BACKWARDS/BACKREST CANE AXLE, ADJUSTABLE TO 50MM BY THE DEALER & SELF PROP=60MM BACKWARDS/BACKREST CANE AXLE, ADJUSTABLE TO 85MM BY THE DEALER	NC : 1275, 1280, 1320, 1330, 1365	148,82
PUMP				
CES1230	<input type="checkbox"/>	PUMP AND SUPPORT		10,43
CHASSIS OPTIONS TYPE				
CES1241	<input type="checkbox"/>	FRONT WHEELS EXTENSION (+ 50 MM OUTWARD)		○
CES1260	<input type="checkbox"/>	SPOKE GUARDS PAIR 600 MM (24") BLACK	NC : 1261	165,88
CES1261	<input type="checkbox"/>	SPOKE GUARDS PAIR CLEAR		165,88
BRAKES TYPE				
CES1270	<input type="checkbox"/>	PUSH TO LOCK BRAKES		◆
CES1275	<input type="checkbox"/>	PULL TO LOCK BRAKES		○
CES1280	<input type="checkbox"/>	ATTENDANT HUB BRAKES (INCLUDING PUSH TO LOCK BRAKES)		178,20
CES1320	<input type="checkbox"/>	OAD WIRE CONTROLLED BRAKE RH	NC : 1390	94,79
CES1330	<input type="checkbox"/>	OAD WIRE CONTROLLED BRAKE LH	NC : 1390	94,79
SAFETY OPTIONS TYPE				
CES1345	<input type="checkbox"/>	TRANSPORTATION BRACKETS		24,64
CES1360	<input type="checkbox"/>	POSTURE BELT - PLASTIC BUCKLE	NC : 1361, 1362, 1363, 1364	31,28
CES1361	<input type="checkbox"/>	HIP BELT, 2-PT, CTR-PULL, PB - M X 460MM PADS, FLAT-MOUNT	NC : 1362, 1363, 1364	199,05
CES1362	<input type="checkbox"/>	HIP BELT, 2-PT, CTR-PULL, PB - L X 620MM PADS, FLAT-MOUNT	NC : 1363, 1364	206,64
CES1363	<input type="checkbox"/>	HIP BELT, 4-PT, CTR-PULL, PB - M X 460MM PADS, FLAT-MOUNT	NC : 1364	234,12
CES1364	<input type="checkbox"/>	HIP BELT, 4-PT, CTR-PULL, PB - L X 620MM PADS, FLAT-MOUNT		241,71
CES1365	<input type="checkbox"/>	TRANSFER KIT (100 MM (4") WHEELS) - ANTI-BARRIER		68,25
CES1370	<input type="checkbox"/>	REAR ANTI-TIPPERS PAIR -	NC : 1375, 1440	79,62
CES1375	<input type="checkbox"/>	REAR ANTI-TIPPERS PAIR WITH TIPPING AID - (REA TYPE)	NC : 1440	125,12
CES1380	<input type="checkbox"/>	REFLECTORS KIT		38,86
CES1390	<input type="checkbox"/>	BRAKE EXTENSION PAIR		10,43



Standard



Composite



Active

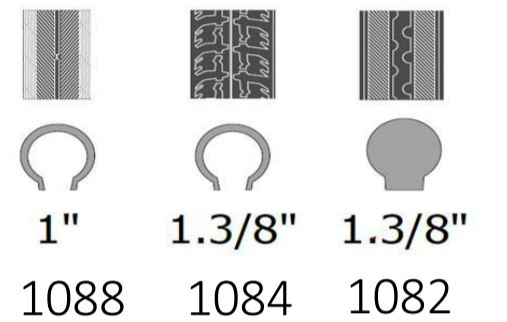

1" 1.3/8" 1.3/8"
1088 1084 1082

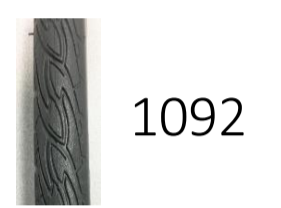

1092



1241



1270

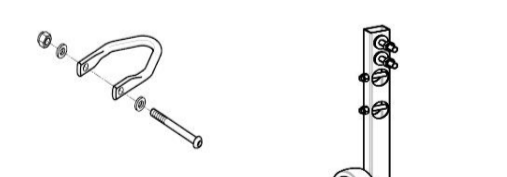

1345

1365

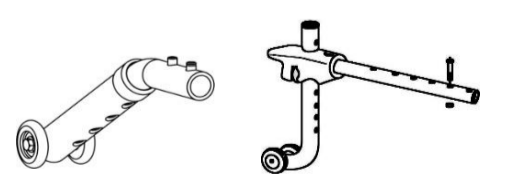

1370

1375





1361 / 1362

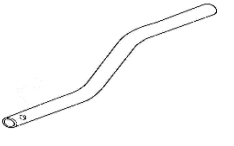

1363 / 1364

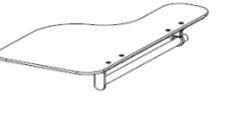

OPTIONS					
CES1430	<input type="checkbox"/>	CANE HOLDER		49,29	 1440
CES1440	<input type="checkbox"/>	TIPPING AID RH		28,44	
CES1451	<input type="checkbox"/>	DRIP STAND SUPPORT WITH DRIPSTAND (WITH BACKBRACE 0940 ONLY)		101,42	

OTHERS OPTIONS					
CES1480	<input type="checkbox"/>	ACRYLIC TRAY	NC : 1483, 1484, 1485	72,83	 1483 / 1484
CES1483	<input type="checkbox"/>	HALF TABLE TRAY, CLEAR, FLIP UP, RH	NC : 1484	72,83	
CES1484	<input type="checkbox"/>	HALF TABLE TRAY, CLEAR, FLIP UP, LH		72,83	 1480 1485
CES1485	<input type="checkbox"/>	COMFORT PADDING FOR HALF TABLE TRAY		90,05	

ACCESSORIES (delivered separtly)					
AP1493219	<input type="checkbox"/>	GUTTER WITH INDEPENDENT SIDE ROTATION, ADJUSTABLE IN HEIGHT AND DEPTH, RIGHT	Only compatible with armrest 0680, 0690, 0695, 0696, 0732	113,17	
AP1493220	<input type="checkbox"/>	GUTTER WITH INDEPENDENT SIDE ROTATION, ADJUSTABLE IN HEIGHT AND DEPTH, LEFT	Only compatible with armrest 0780, 0790, 0795, 0796, 0832	113,17	

Possible widths of the Matrix backrests depending on the seat width

Backrest Width	(mm)	Seat Width (mm)					
		380	405	430	455	480	505
360		○					
380		○	○				
410		○	○	○			
430			○	○	○		
460				○	○	○	
480					○	○	○
510						○	○

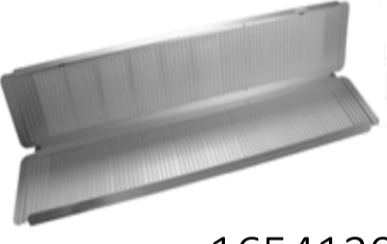
RAMPS					
1440530	<input type="checkbox"/>	Fiberglass Folding Mono Ramp Folded dimensions: 2000 x 230 mm 16.3 kg - maximum capacity: 300 kg		1 787,68	 1440530
1654128	<input type="checkbox"/>	Basic ramp 2 telescopic parts in aluminum and non-slip coating. Folded dimensions: 1210 x 194 mm 8.8 kg per pair - maximum capacity: 270 kg		402,84	 1654128
1654129	<input type="checkbox"/>	Quick2go Compact 3-part aluminum telescopic ramp with non-slip coating Folded dimensions: 870 x 237 mm 13.6 kg per pair - maximum capacity: 260 kg		805,69	 1654129
1654130	<input type="checkbox"/>	Aluminium folding mono ramp Folded dimensions: 1824 x 714 mm 13.9 kg - maximum capacity: 300 kg		426,54	 1654130