

Invacare[®] Action^{®3} NG Transit

Please contact Invacare EU Export Customer Services on :-
Tel : +33 247 626980 ; Email : serviceclient_export@invacare.com
Or visit our website : www.invacare.eu.com



Invacare[®] Action^{®3} NG Transit

Transit manual aluminium folding wheelchair



Description: -

Seat width HT = seat width + 160 mm
- Weight: from 13.5 kg
- Maximum user weight: 125 kg -
2-year warranty period excluding wear parts

Date :

Purchase Order :

Customer Code :

Distributor Stamp::



Invacare Unique Customization Service
Please specify the quote or special production number:

Please make your selection with a cross in the box ◆ Standard feature ○ Free of charge option

CODE	DESCRIPTION	NC : Non Compatible NC : 9999 = not compatible with the reference 9999	Euros	
CEF0036	<input type="checkbox"/> Invacare [®] Action ^{®3} NG Transit - Folding Backrest		382,46	
CEF0041	<input type="checkbox"/> Invacare [®] Action ^{®3} NG Transit - Reclining Backrest		382,46	
ALBER				
CEF0090	<input type="checkbox"/> BRACKET FOR VIAMOBIL ECO V14	NC : 0905, 0906, 0907, 1201, 1370, 1430, 1441, 1451	414,26	
PROPULSION TYPE				
CEF0110	<input type="checkbox"/> Transit		◆	
SEAT				
SEAT WIDTH				
CEF0180	<input type="checkbox"/> 380 mm	NC : 0852, 0855		○
CEF0190	<input type="checkbox"/> 405 mm			○
CEF0200	<input type="checkbox"/> 430 mm	NC : 0853		◆
CEF0210	<input type="checkbox"/> 455 mm	NC : 0853		○
CEF0220	<input type="checkbox"/> 480 mm	NC : 0853, 0854		○
CEF0230	<input type="checkbox"/> 505 mm	NC : 0853, 0854, 0855, 0856		○
SEAT DEPTH				
CEF0240	<input type="checkbox"/> 400 mm	NC : 0879		◆
CEF0250	<input type="checkbox"/> 450 mm	NC : 0853, 0878		○
CEF0252	<input type="checkbox"/> 400 TO 450 MM ADJUSTABLE SEAT DEPTH	NC : 0330, 0350	30,33	
SEAT HEIGHT				
CEF0260	<input type="checkbox"/> 510 mm	NC : 1035, 1050		○
CEF0270	<input type="checkbox"/> 485 mm			◆
CEF0280	<input type="checkbox"/> 460 mm			○
SEAT UPHOLSTERY TYPE				
CEF0330	<input type="checkbox"/> NYLON WITHOUT LOOP BANDS SEAT UPHOLSTERY			◆
CEF0340	<input type="checkbox"/> NYLON WITH LOOP BANDS SEAT UPHOLSTERY			○
CEF0350	<input type="checkbox"/> PADDED NYLON SEAT UPHOLSTERY		30,33	
BACKREST				
BACKREST TYPE - Anti-tippers required with reclining backrests				
CEF0435	<input type="checkbox"/> TILTING BY MEANS OF RACKS 0°/30° - WITH TENSIONER - HEIGHTS 390/ 410/ 430 MM (DELIV.430 MM)	NC : 0940		◆
CEF0445	<input type="checkbox"/> RECLINING (GAS SPRING) 0/30° BACKREST INCL. BACKRACE & PASSIVE REAR WHEEL POS. ONLY - 3 HEIGHTS 390/410/430 MM (DELIV.430 MM)	NC : 0940		○
CEF0450	<input type="checkbox"/> RECLINING (GAS SPRING) 0/30° BACKREST INCL. BACKRACE & PASSIVE REAR WHEEL POS. ONLY - 3 HEIGHTS 470/490/510 MM (DELIV.510 MM)	NC : 0940	33,18	
CEF0455	<input type="checkbox"/> FOLDING 7° BACKREST - 430 MM HEIGHT			◆
CEF0460	<input type="checkbox"/> FOLDING 7° BACKREST - 510 MM HEIGHT	NC : 0480, 0481	33,18	

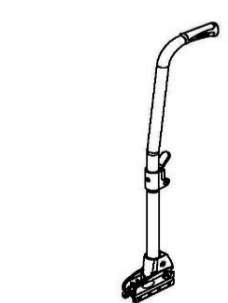

0455 / 0460

BACKREST UPHOLSTERY TYPE				
CEF0474	<input type="checkbox"/>	LUMBAR SUPPORT (+1 STRAP) BI MATERIAL PADDED COVER INCL. BACK POCKET		33,08
CEF0475	<input type="checkbox"/>	LUMBAR SUPPORT (+1 STRAP) PADDED SHAPED COVER		◆
CEF0478	<input type="checkbox"/>	CONTOUR ADJUSTABLE (3+1 STRAPS) BI MATERIAL PADDED COVER INCL. BACK POCKET	NC : 0940	66,16
CEF0479	<input type="checkbox"/>	CONTOUR ADJUSTABLE (3+1 STRAPS) PADDED SHAPED COVER	NC : 0940	33,08
CEF0480	<input type="checkbox"/>	CONTOUR ADJUSTABLE (7+1 STRAPS) PADDED SHAPED COVER	NC : 0940	138,39
CEF0481	<input type="checkbox"/>	CONTOUR ADJUSTABLE (7+1 STRAPS) BI MATERIAL PADDED COVER INCL. BACK POCKET	NC : 0940	189,57
HANGERS/FOOTPLATES				
HANGERS RH TYPE				
CEF0510	<input type="checkbox"/>	80° STRAIGHT RH SWING IN/SWING OUT HANGER		◆
CEF0520	<input type="checkbox"/>	ELEVATING LEGREST (0° TO 75°) RH SWING IN/SWING OUT HANGER (INCLUDING CALFPAD)	NC : 0611, 0930, 0935, 0936	73,82
CEF0545	<input type="checkbox"/>	AMPUTEE LEGREST RH	NC : 0600, 0610, 0611, 0930, 0936	140,28
HANGERS LH TYPE				
CEF0560	<input type="checkbox"/>	WITHOUT LH HANGER		◆
CEF0570	<input type="checkbox"/>	ELEVATING LEGREST (0° TO 75°) LH SWING IN/SWING OUT HANGER (INCLUDING CALFPAD)	NC : 0611, 0930, 0935, 0936	73,82
CEF0595	<input type="checkbox"/>	AMPUTEE LEGREST LH	NC : 0611, 0620, 0630, 0930, 0936	140,28
FOOTPLATES RH TYPE				
CEF0600	<input type="checkbox"/>	FLIP UP RH FOOTPLATE - (INCLUDING HEEL STRAP)		◆
CEF0610	<input type="checkbox"/>	FLIP UP DEPTH & ANGLE AJUSTABLE RH FOOTPLATE - (INCLUDING HEEL STRAP)		26,43
CEF0611	<input type="checkbox"/>	FLIP UP ONE PIECE FOOTPLATE - DEPTH & ANGLE ADJUSTABLE	NC : 0620, 0630, 0935, 0936	234,12
FOOTPLATES LH TYPE				
CEF0620	<input type="checkbox"/>	FLIP UP LH FOOTPLATE - (INCLUDING HEEL STRAP)		◆
CEF0630	<input type="checkbox"/>	FLIP UP DEPTH & ANGLE AJUSTABLE LH FOOTPLATE - (INCLUDING HEEL STRAP)		26,43
ARMRESTS				
ARMRESTS RH FORM IN BLACK COLOR				
CEF0640	<input type="checkbox"/>	REMOVABLE RH (N°1) AUTOLOCK SAFETY DEVICE INCLUDED - DESK	NC : 0760, 0770, 0772, 0780, 0790, 0795, 0796, 0798, 1480	◆
CEF0650	<input type="checkbox"/>	REMOVABLE RH (N°1) AUTOLOCK SAFETY DEVICE INCLUDED - FULL LENGTH	NC : 0760, 0770, 0772, 0780, 0790, 0795, 0796, 0798	24,64
CEF0656	<input type="checkbox"/>	REMOVABLE AND CONTINUOUSLY HEIGHT-ADJUSTABLE FROM 200 MM TO 280 MM - SHORT NARROW GUTTER (330 MM) WITHOUT ROTATION	NC : 0760, 0770, 0772, 0780, 0790, 0795, 0796, 0798, 1480	113,17
CEF0660	<input type="checkbox"/>	SWING AWAY DETACHABLE RH (N°2) - DESK	NC : 0740, 0750, 0756, 0772, 0780, 0790, 0795, 0796, 1480	○
CEF0670	<input type="checkbox"/>	SWING AWAY DETACHABLE RH (N°2) - FULL LENGTH	NC : 0740, 0750, 0756, 0772, 0780, 0790, 0795, 0796, 0798	24,64
CEF0672	<input type="checkbox"/>	LIFTABLE AND REMOVABLE, HEIGHT-ADJUSTABLE FROM 170 TO 295 MM - SHORT (330 MM) NON-ROTATING NARROW TROUGH WITH CLOTHES GUARD AND ERGONOMIC SUPPORT HANDLE	NC : 0740, 0750, 0760, 0770, 0795, 0796, 0798, 1480	113,17
CEF0680	<input type="checkbox"/>	SWING AWAY DETACHABLE RH (N°3) - DESK	NC : 0740, 0750, 0756, 0760, 0770, 0795, 0796, 0798, 1480	117,54
CEF0690	<input type="checkbox"/>	SWING AWAY DETACHABLE RH (N°3) - FULL LENGTH	NC : 0740, 0750, 0756, 0760, 0770, 0795, 0796	140,28
CEF0695	<input type="checkbox"/>	REMOVABLE RH (N°4) AUTOLOCK SAFETY DEVICE INCLUDED - DESK	NC : 0740, 0750, 0756, 0760, 0770, 0772, 0780, 0790, 1480	117,54
CEF0696	<input type="checkbox"/>	REMOVABLE RH (N°4) AUTOLOCK SAFETY DEVICE INCLUDED - FULL LENGTH	NC : 0740, 0750, 0756, 0760, 0770, 0772, 0780, 0790	140,28
CEF0698	<input type="checkbox"/>	REMOVABLE AND HEIGHT ADJUSTABLE - SHORT NARROW GUTTER (330 MM) WITHOUT ROTATION	NC : 0740, 0750, 0756, 0760, 0770, 0772, 0780, 0790, 1480	113,17
CEF0732	<input type="checkbox"/>	REMOVABLE RH (N°4) AUTOLOCK SAFETY DEVICE INCLUDED - ARMPAD HEMI BLACK PU TR26	NC : 1480	113,17

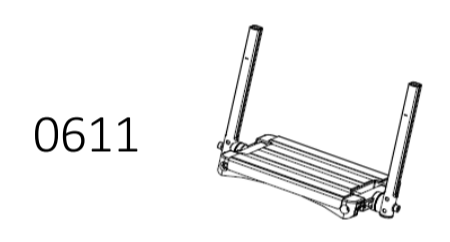
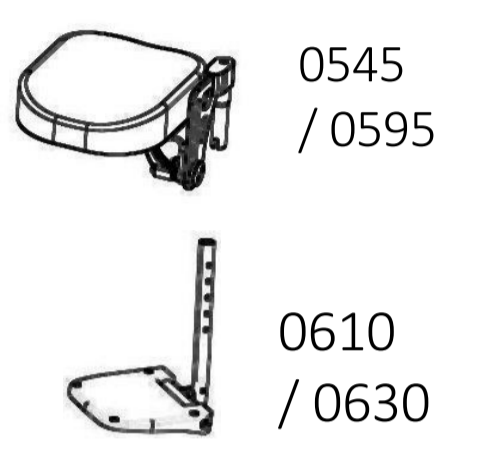
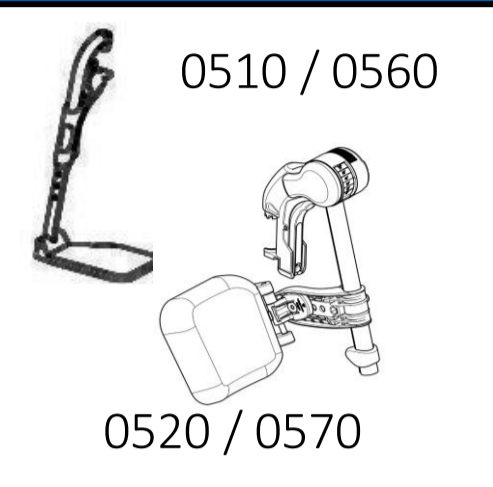
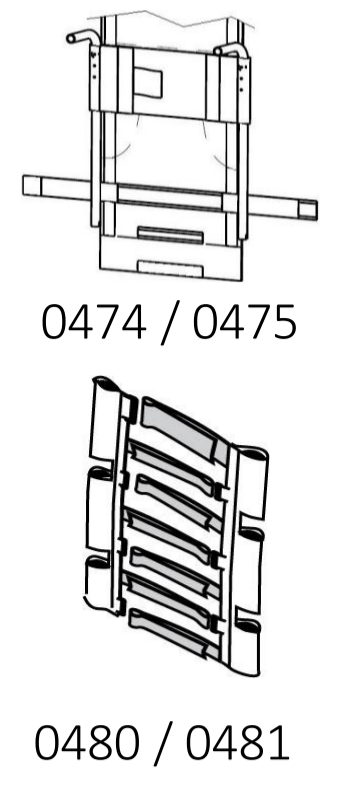

ARMRESTS LH FORM IN BLACK COLOR				
CEF0740	<input type="checkbox"/>	REMOVABLE LH (N°1) AUTOLOCK SAFETY DEVICE INCLUDED - DESK	NC : 1480	◆
CEF0750	<input type="checkbox"/>	REMOVABLE LH (N°1) AUTOLOCK SAFETY DEVICE INCLUDED - FULL LENGTH		24,64
CEF0756	<input type="checkbox"/>	REMOVABLE AND CONTINUOUSLY HEIGHT-ADJUSTABLE FROM 200 MM TO 280 MM - SHORT NARROW GUTTER (330 MM) WITHOUT ROTATION	NC : 1480	113,17
CEF0760	<input type="checkbox"/>	SWING AWAY DETACHABLE LH (N°2) - DESK	NC : 1480	○
CEF0770	<input type="checkbox"/>	SWING AWAY DETACHABLE LH (N°2) - FULL LENGTH		24,64
CEF0772	<input type="checkbox"/>	LIFTABLE AND REMOVABLE, HEIGHT-ADJUSTABLE FROM 170 TO 295 MM - SHORT (330 MM) NON-ROTATING NARROW TROUGH WITH CLOTHES GUARD AND ERGONOMIC SUPPORT HANDLE	NC : 1480	113,17
CEF0780	<input type="checkbox"/>	SWING AWAY DETACHABLE LH (N°3) - DESK	NC : 1480	117,54
CEF0790	<input type="checkbox"/>	SWING AWAY DETACHABLE LH (N°3) - FULL LENGTH		140,28
CEF0795	<input type="checkbox"/>	REMOVABLE LH (N°4) AUTOLOCK SAFETY DEVICE INCLUDED - DESK	NC : 1480	117,54
CEF0796	<input type="checkbox"/>	REMOVABLE LH (N°4) AUTOLOCK SAFETY DEVICE INCLUDED - FULL LENGTH		140,28
CEB0698	<input type="checkbox"/>	REMOVABLE AND HEIGHT ADJUSTABLE - SHORT NARROW GUTTER (330 MM) WITHOUT ROTATION	NC : 1480	113,17
CEF0832	<input type="checkbox"/>	REMOVABLE LH (N°4) AUTOLOCK SAFETY DEVICE INCLUDED - ARMPAD HEMI BLACK PU TR26	NC : 1480	113,17
SEAT CUSHION TYPE				
Cushion				
CEF0849	<input type="checkbox"/>	BASIC 60 MM FOAM CUSHION	NC : 0853, 0854, 0855, 0856, 0873	33,08
CEF0853	<input type="checkbox"/>	CLASSIC VISCO CUSHION 375X 400 MM	NC : 0873, 0878, 0879	76,78
CEF0854	<input type="checkbox"/>	CLASSIC VISCO CUSHION 405 X 400 MM	NC : 0873, 0878, 0879	65,40
CEF0855	<input type="checkbox"/>	CLASSIC VISCO CUSHION 430 X 430 MM	NC : 0873, 0878, 0879	65,40
CEF0856	<input type="checkbox"/>	CLASSIC VISCO CUSHION 455 X 400 MM	NC : 0873, 0878, 0879	76,78
CEF0873	<input type="checkbox"/>	MATRX FLO-TECH IMAGE CUSHION		246,45
SEAT CUSHION DEPTH				
CEF0878	<input type="checkbox"/>	FOR 400 MM SEAT DEPTH		○
CEF0879	<input type="checkbox"/>	FOR 450 MM SEAT DEPTH		○
OTHER SEATING OPTIONS				
CEF0852	<input type="checkbox"/>	SEAT RIGIDIZER	(Mandatory: Choose a seat cushion)	61,61
CEF0882	<input type="checkbox"/>	LATERAL POSITIONING PADS (PAIR)		237,91
CEF0905	<input type="checkbox"/>	NECKREST BLACK PU TR26 (INCLUDING BACKBRACE EXCEPT FOR LAGUNA)	NC : 0906, 0907, 0940	60,10
CEF0906	<input type="checkbox"/>	HEADREST BLACK PU TR26 (INCLUDING BACKBRACE EXCEPT FOR LAGUNA)	NC : 0907, 0940	199,05
CEF0907	<input type="checkbox"/>	HEADREST WITH CHEEK SUPPORT BLACK PU TR26 (INCLUDING BACKBRACE EXCEPT FOR LAGUNA)	NC : 0940	217,06
CEF0930	<input type="checkbox"/>	ADJUSTABLE CALF STRAP		10,43
CEF0935	<input type="checkbox"/>	LONGER FOOTREST TUBE (UL= 450-530 MM)	NC : 0936	17,06
CEF0936	<input type="checkbox"/>	SHORTER FOOTREST SUPPORT (PAIR) (UL= 230-430 MM)		83,41
CEF0940	<input type="checkbox"/>	BACKBRACE		47,39
COLOURS				
CEF0961	<input type="checkbox"/>	SLATE GREY (RAL7024 FINE TEXTURE)		○
CEF0964	<input type="checkbox"/>	PEARL WHITE		○
CEF0966	<input type="checkbox"/>	MATT BLACK		○
CEF0969	<input type="checkbox"/>	RED MATT		○
CEF0974	<input type="checkbox"/>	NAVY BLUE		○
CEF0980	<input type="checkbox"/>	ANTHRACITE BLACK		○
CEF0991	<input type="checkbox"/>	SPECIAL COLOUR	RAL :	On Request
CASTER HOUSING TYPE				
CEF0995	<input type="checkbox"/>	STANDARD		◆
FRONT WHEELS				
CEF1005	<input type="checkbox"/>	200 X 32 MM (8" X 1.1/4") - BLACK PNEUMATIC TYRE		○
CEF1010	<input type="checkbox"/>	200 X 30 MM (8" X 1.1/4") - BLACK SOLID TYRE		○
CEF1030	<input type="checkbox"/>	200 X 45 MM (8" X 2") - BLACK SOLID TYRE		○
CEF1035	<input type="checkbox"/>	150 X 30 MM (6" X 1.1/4") - BLACK SOLID TYRE MEDIUM HARD		○
CEF1050	<input type="checkbox"/>	150 X 30 MM (6" X 1.1/4") - BLACK SOLID TYRE		◆



0698 / 0798

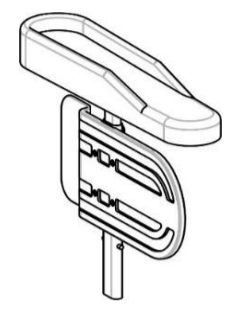

0732 / 0832



0849

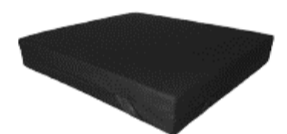

0853 / 0854
0855 / 0856



0873



0882

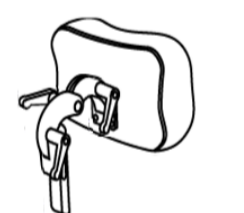

0905

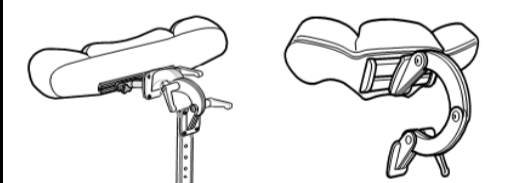

0906

0907













0961 0964 0966

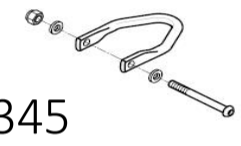

0974 0969 0980

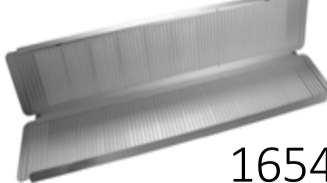

1010 1050

REAR WHEELS				
REAR WHEEL SIZE				
CEF1062	<input type="checkbox"/>	12" - 305 mm		◆
REAR WHEEL TYPE				
CEF1073	<input type="checkbox"/>	DRUM BRAKE (20/22/24" : COLORLESS HUB, CLEAR ANODIZED RIM & STAINLESS STEEL SPOKES / 12" : BLACK PLASTIC HUB & RIM)	NC : 1270	○
CEF1074	<input type="checkbox"/>	COMPOSITE (BLACK PLASTIC HUB & RIM)	NC : 1280	◆
TYRE TYPE				
CEF1082	<input type="checkbox"/>	TYRES SOLID BLACK 35 MM (1"3/8)		◆
REAR WHEELS AXLE TYPE				
CEF1170	<input type="checkbox"/>	FIXED AXLE		◆
REAR WHEELS POSITION				
CEF1200	<input type="checkbox"/>	PASSIVE REAR WHEELS POSITION - 25MM BACKWARDS/BACKREST CANE AXLE (12,5MM with Active Rear Wheel Support and Seat Depth 500MM)		◆
CEF1201	<input type="checkbox"/>	DUAL AMPUTEE REAR WHEELS POSITIONS - TRANSIT=75MM BACKWARDS/BACKREST CANE AXLE, ADJUSTABLE TO 50MM BY THE DEALER & SELF PROP=60MM BACKWARDS/BACKREST CANE AXLE, ADJUSTABLE TO 85MM BY THE DEALER	NC : 1280	148,82
PUMP				
CEF1230	<input type="checkbox"/>	PUMP AND SUPPORT		10,43
CHASSIS OPTIONS TYPE				
CEF1241	<input type="checkbox"/>	FRONT WHEELS EXTENSION (+ 50 MM OUTWARD)		○  1241
BRAKES TYPE				
CEF1270	<input type="checkbox"/>	PUSH TO LOCK BRAKES		◆  1270
CEF1280	<input type="checkbox"/>	ATTENDANT HUB BRAKES (INCLUDING PUSH TO LOCK BRAKES)	178,20	
SAFETY OPTIONS TYPE				
CEF1345	<input type="checkbox"/>	TRANSPORTATION BRACKETS		24,64  1345
CEF1360	<input type="checkbox"/>	POSTURE BELT - PLASTIC BUCKLE	NC : 1361, 1362, 1363, 1364	◆
CEF1361	<input type="checkbox"/>	HIP BELT, 2-PT, CTR-PULL, PB - M X 460MM PADS, FLAT-MOUNT	NC : 1362, 1363, 1364	199,05  1361 / 1362
CEF1362	<input type="checkbox"/>	HIP BELT, 2-PT, CTR-PULL, PB - L X 620MM PADS, FLAT-MOUNT	NC : 1363, 1364	206,64  1363 / 1364
CEF1363	<input type="checkbox"/>	HIP BELT, 4-PT, CTR-PULL, PB - M X 460MM PADS, FLAT-MOUNT	NC : 1364	234,12  1370
CEF1364	<input type="checkbox"/>	HIP BELT, 4-PT, CTR-PULL, PB - L X 620MM PADS, FLAT-MOUNT		241,71
CEF1370	<input type="checkbox"/>	REAR ANTI-TIPPERS PAIR	NC : 1441	79,62
OPTIONS				
CEF1430	<input type="checkbox"/>	CANE HOLDER		49,29  1480
CEF1441	<input type="checkbox"/>	TIPPING AID RH		28,44
CEF1451	<input type="checkbox"/>	DRIP STAND SUPPORT WITH DRIPSTAND (WITH BACKBRACE 0940 ONLY)		101,42
OTHERS OPTIONS				
CEF1480	<input type="checkbox"/>	ACRYLIC TRAY		72,83
ACCESSORIES (delivered separtly)				
AP1493219	<input type="checkbox"/>	GUTTER WITH INDEPENDENT SIDE ROTATION, ADJUSTABLE IN HEIGHT AND DEPTH, RIGHT	Only compatible with armrest 0680, 0690, 0695, 0696, 0732	113,17  1654130
AP1493220	<input type="checkbox"/>	GUTTER WITH INDEPENDENT SIDE ROTATION, ADJUSTABLE IN HEIGHT AND DEPTH, LEFT	Only compatible with armrest 0780, 0790, 0795, 0796, 0832	113,17  1654128
RAMPS				
1440530	<input type="checkbox"/>	Fiberglass Folding Mono Ramp Folded dimensions: 2000 x 230 mm 16.3 kg - maximum capacity: 300 kg"		1 787,68  1440530
1654128	<input type="checkbox"/>	Basic ramp 2 telescopic parts in aluminum and non-slip coating - Folded dimensions: 1210 x 194 mm. 8.8 kg per pair - maximum capacity: 270 kg		402,84  1654129
1654129	<input type="checkbox"/>	Quick2go Compact 3-part aluminum telescopic ramp with non-slip coating Folded dimensions: 870 x 237 mm 13.6 kg per pair - maximum capacity: 260 kg		805,69
1654130	<input type="checkbox"/>	Aluminium folding mono ramp Folded dimensions: 1824 x 714 mm 13.9 kg - maximum capacity: 300 kg		426,54