

Rea® Dahlia® 45° MatrX

Please contact Invacare EU Export Customer Services on :-
 Tel : +33 247 626980 ; Email : serviceclient_export@invacare.com
 Or visit our website : www.invacare.eu.com



Rea® Dahlia® 45° MatrX Folding Frame Steel Manual Wheelchair



Description:

- Reclining seat up to 45° *
- Backrest adjustable in angle or tilting from 0° to 30° *
- Reduced overall width: Seat width +180 mm with 20", 22", 24" wheels; +160 mm with 16" wheels.
- Wheelbase adjustable over 90 mm
- delivered in the rear position
- Weight: from 35kg.
- Max user weight: 135 kg.
- 2-year warranty period excluding wear parts
- * see table at the end of the measurement sheet

Date :

Purchase Order :

Customer Code :

Distributor Stamp::



Invacare Unique Customization Service
 Please specify the quote or special production number:

Please make your selection with a cross in the box Standard feature Free of charge option

CODE	DESCRIPTION	NC : Non Compatible NC : 9999 = not compatible with the reference 9999	Euros
BXB0018	<input type="checkbox"/> Rea® Dahlia® 45° MatrX		2 895,73
PROPULSION TYPE			
BXB0035	<input type="checkbox"/> SELF PROPELLED: 24"/ 22" /20" WHEELS	NC : 1548	◆
BXB0042	<input type="checkbox"/> ONE ARM DRIVE RIGHT (NEW DHR SYSTEM) - QUICK RELEASE AXLES	NC : 0120, 0140, 1515, 1542, 1544, 1546, 1770	832,23
BXB0044	<input type="checkbox"/> ONE ARM DRIVE LEFT (NEW DHR SYSTEM) - QUICK RELEASE AXLES	NC : 0120, 0140, 1515, 1542, 1544, 1546, 1770	832,23
SEAT			
SEAT WIDTH			
BXB0050	<input type="checkbox"/> 390 MM (SMALL CHASSIS)	NC : 0423, 0424, 0425, 0426 1770	○
BXB0060	<input type="checkbox"/> 440 MM (MEDIUM CHASSIS)	NC : 0421, 0425, 0426	○
BXB0070	<input type="checkbox"/> 490 MM (LARGE CHASSIS)	NC : 0421, 0422, 0423	○
SEAT WIDTH EXTENSION (PRE ADJUSTMENT)			
BXB0080	<input type="checkbox"/> + 50 MM		○
BXB0100	<input type="checkbox"/> WITHOUT SEAT WIDTH EXTENSION		◆
SEAT DEPTH			
BXB0110	<input type="checkbox"/> 430-500 MM		◆
SEAT HEIGHT			
BXB0120	<input type="checkbox"/> 350 MM/ 14"; (20" AND 16")	NC : 0630, 0770, 0810, 0850, 1465, 1770	○
BXB0130	<input type="checkbox"/> 380 MM/ 15"; (22", 20" AND 16")	NC : 0630, 0770, 0810, 0850, 1465, 1770	○
BXB0140	<input type="checkbox"/> 400 MM/ 16"; (20")	NC : 0630, 0770, 0810, 0850, 1465	○
BXB0150	<input type="checkbox"/> 430 MM/ 17"; (20" AND 22")	NC : 0630, 1465	○
BXB0160	<input type="checkbox"/> 450 MM/ 18"; (24" AND 22")	NC : 1465	◆
BXB0170	<input type="checkbox"/> 480 MM/ 19"; (24" AND 16")		○
SEAT CUSHION			
BXB0220	<input type="checkbox"/> CUSHION MISTRAL 2 LAYER	NC : 0290, 0305	○
BXB0230	<input type="checkbox"/> CUSHION FLOSHAPE		○
BXB0240	<input type="checkbox"/> CUSHION MATRX CONTOUR VISCO NG	NC : 0290; 0300, 0305	◆
SEAT UPHOLSTERY			
BXB0290	<input type="checkbox"/> BLACK PLUSH TR35		○
BXB0300	<input type="checkbox"/> BLACK PU TR26 - MUTLI STRETCH PU COATED FABRIC		◆
BXB0305	<input type="checkbox"/> BLACK SPACER TR36		○



BACKREST				
BACKREST TUBE				
BXB0320	<input type="checkbox"/>	STRAIGHT (FLEX 3, MATRX AND LAGUNA)		◆
BACKREST JOINT POSITION				
BXB0340	<input type="checkbox"/>	WITHOUT BACKREST JOINT WIDTH EXTENSION		◆
BACKREST TYPE				
BXB0350	<input type="checkbox"/>	MATRX ELITE E2 (INCL. HARDWARE MOUNTED TO FRAME, BACKREST SUPPLIED IN BOX) - BACKREST HEIGHT MATRX BACKRESTS MANDATORY		◆
BXB0360	<input type="checkbox"/>	MATRX ELITE DEEP E2 (INCL. HARDWARE MOUNTED TO FRAME, BACKREST SUPPLIED IN BOX) - BACKREST HEIGHT MATRX BACKRESTS MANDATORY		○
BACKREST HEIGHT MATRX BACKRESTS				
BXB0413	<input type="checkbox"/>	HEIGHT 41 CM		○
BXB0415	<input type="checkbox"/>	HEIGHT 46 CM		○
BXB0417	<input type="checkbox"/>	HEIGHT 51 CM		◆
BACKREST WIDTH MATRX BACKRESTS				
BXB0421	<input type="checkbox"/>	380 MM - INDICATIVE BUST WIDTH : 290 MM		○
BXB0422	<input type="checkbox"/>	410 MM - INDICATIVE BUST WIDTH : 315 MM		○
BXB0423	<input type="checkbox"/>	430 MM - INDICATIVE BUST WIDTH : 340 MM		○
BXB0424	<input type="checkbox"/>	460 MM - INDICATIVE BUST WIDTH : 370 MM		○
BXB0425	<input type="checkbox"/>	480 MM - INDICATIVE BUST WIDTH : 390 MM		○
BXB0426	<input type="checkbox"/>	510 MM - INDICATIVE BUST WIDTH : 420 MM		○
BACKREST COVER/ CUSHION				
BXB0540	<input type="checkbox"/>	ANGLE ADJUSTABLE PUSHBAR	145,97	
BXB0550				
BXB0560	<input type="checkbox"/>	Height-adjustable and removable push handles (BXB0570)		◆
BXB0570				
SEATING				
SEAT TILT TYPE				
BXB0580	<input type="checkbox"/>	ASSISTANT HAND OPERATED GAS PISTON FOR SEAT TILT - BACKREST RECLINE MANDATORY		◆
BXB0595	<input type="checkbox"/>	ELECTRIC BY REMOTE CONTROL - COMPLIES WITH EN 12184 : 2014	NC : 0600, 0620, 0630, 1770, 1860	995,26
BACKREST RECLINE OPERATION TYPE				
BXB0600	<input type="checkbox"/>	ASSISTANT OPERATED GAS PISTON FOR BACKREST RECLINE		◆
BXB0620	<input type="checkbox"/>	FIXED BACKREST ANGLE (BARREL SCREW)		○
LEGRESTS / FOOTRESTS				
CENTRAL LEGRESTS TYPE				
BXB0630	<input type="checkbox"/>	CENTRAL LEGREST, INCL CALFPAD AND FOOTREST.	NC : 0640, 0650, 0655, 0660, 0670, 0690, 0710, 0720, 0740, 0760, 0770, 0790, 0810, 0830, 0850, 1000, 1300, 1310, 1311, 1312, 1313	900,47
LEGRESTS / HANGERS ADJUSTMENT				
BXB0640	<input type="checkbox"/>	LOW POSITION, STANDARD		◆
BXB0650	<input type="checkbox"/>	HIGH POSITION FOR LONGER LEGS, 50 MM HIGHER		109,00
BXB0655	<input type="checkbox"/>	90° HANGER ATTACHMENT	NC : 0670, 0690, 0720, 0740	52,30
LEGRESTS / HANGERS LH TYPE				
BXB0660	<input type="checkbox"/>	HANGER ANGLE ADJUSTABLE - LH. WITH KNEE PAD AND CALF SUPPORT	NC : 0760, 0830, 1290	◆
BXB0670	<input type="checkbox"/>	HANGER FIXED 80 DEG, SWING IN SWING OUT - ALU 2003, LH		○
BXB0690	<input type="checkbox"/>	LEGREST AMPUTEE	NC : 0760, 0770, 0790, 0810, 1290, 1300, 1310	104,28
LEGRESTS / HANGERS RH TYPE				
BXB0710	<input type="checkbox"/>	HANGER ANGLE ADJUSTABLE - RH. WITH KNEE PAD AND CALF SUPPORT	NC : 0710, 0830, 1290	◆
BXB0720	<input type="checkbox"/>	HANGER FIXED 80 DEG, SWING IN SWING OUT		○
BXB0740	<input type="checkbox"/>	LEGREST AMPUTEE	NC : 0760, 0770, 0830, 0850, 1290, 1300, 1310	140,28



0350



0360





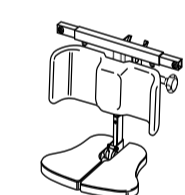



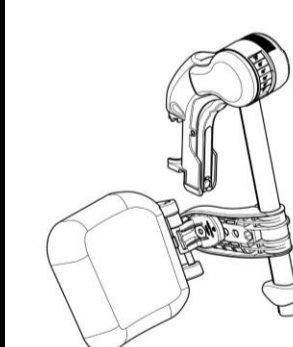
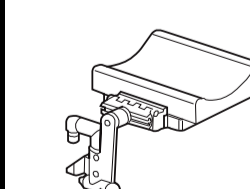



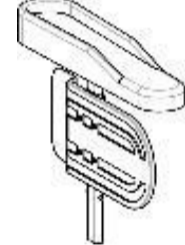

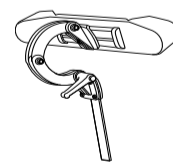

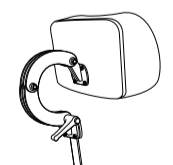

0540

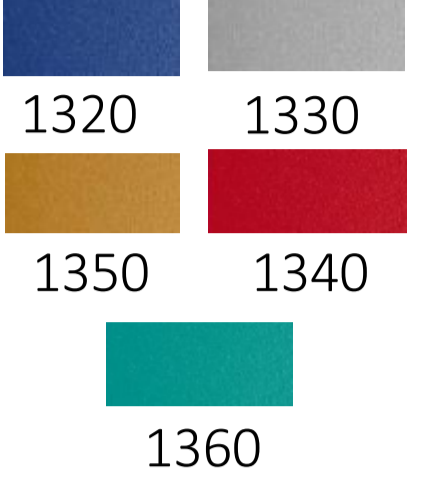

0630

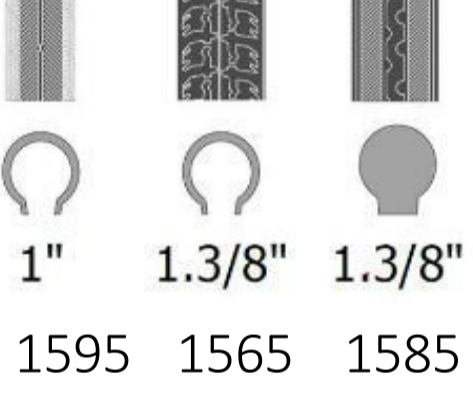
0660
07100670
07200690
0740

FOOTRESTS					
FOOTRESTS ONE PIECE					
BXB0760	<input type="checkbox"/>	FOOTREST ONE PIECE DEPTH AND ANGLE ADJUSTABLE SHORT TUBE.	NC : 0630, 0660, 0690, 0710, 0740, 0790, 0830, 1311, 1312, 1313	202,84	 0770
BXB0770	<input type="checkbox"/>	FOOTREST ONE PIECE DEPTH AND ANGLE ADJUSTABLE LONG TUBE.	NC : 0790, 0810, 0830, 0850, 1270, 1280, 1311, 1312, 1313	202,84	
FOOTRESTS LH TYPE					
BXB0790	<input type="checkbox"/>	FOOTREST LOWER PART, DEPTH AND ANGLE ADJUSTABLE WITH SHORT TUBE AND HEEL STRAP, LH	NC : 0660, 0690, 0760, 0770	○	
BXB0810	<input type="checkbox"/>	FOOTREST LOWER PART, DEPTH AND ANGLE ADJUSTABLE WITH LONG TUBE AND HEEL STRAP, LH	NC : 1290	◆	
FOOTRESTS RH TYPE					
BXB0830	<input type="checkbox"/>	FOOTREST LOWER PART, DEPTH AND ANGLE ADJUSTABLE WITH SHORT TUBE AND HEEL STRAP, RH	NC : 0710, 0740, 0760, 0770	○	
BXB0850	<input type="checkbox"/>	FOOTREST LOWER PART, DEPTH AND ANGLE ADJUSTABLE WITH LONG TUBE AND HEEL STRAP, RH	NC : 1290	◆	
ARMRESTS (Height adjustable, Autolock attachment included)					
ARMRESTS LH TYPE					
BXB0860	<input type="checkbox"/>	STRAIGHT NARROW PAD, LH	NC : 1717	○	 0860  0870  0890
BXB0870	<input type="checkbox"/>	STANDARD PAD, LH	NC : 0985, 1717	◆	
BXB0875	<input type="checkbox"/>	HIGH ARMREST (+55MM), STANDARD PAD, LH	NC : 0985, 1717	36,20	
BXB0890	<input type="checkbox"/>	HEMIPLEGIC ARMRESTS, LH.	NC : 0980,0985, 1710, 1715, 1717, 1720, 1730, 1735, 1740	113,17	
BXB0910	<input type="checkbox"/>	WITHOUT ARMREST, LH	NC : 0985, 1710, 1715, 1720, 1730, 1735, 1740	○	
ARMRESTS RH TYPE					
BXB0920	<input type="checkbox"/>	STRAIGHT NARROW PAD, RH	NC : 1716	○	
BXB0930	<input type="checkbox"/>	STANDARD PAD, RH	NC : 0985, 1716	◆	
BXB0935	<input type="checkbox"/>	HIGH ARMREST (+55MM), STANDARD PAD, RH	NC : 0985, 1716	36,20	
BXB0950	<input type="checkbox"/>	HEMIPLEGIC ARMRESTS, RH	NC : 0980, 0985, 1710, 1715, 1716, 1720, 1730, 1735, 1740	113,17	
BXB0970	<input type="checkbox"/>	WITHOUT ARMREST, RH	NC : 0985, 1710, 1715, 1720, 1730, 1735, 1740	○	
SEATING OPTIONS					
ARMREST OPTIONS					
BXB0980	<input type="checkbox"/>	PAD, SIDE REST		33,18	
BXB0985	<input type="checkbox"/>	PADDED ARMPAD COVER, BLACK PLUSH TR35	NC : 1710, 1715, 1716, 1717, 1720, 1725, 1730, 1735, 1740	41,71	
SEAT OPTIONS					
BXB0990	<input type="checkbox"/>	INCONTINENCE COVER		33,18	 1000
BXB1000	<input type="checkbox"/>	ABDUCTION CUSHION	NC : 1020	246,45	
BXB1010	<input type="checkbox"/>	SEAT PLATE EXTENSION IN WIDTH, FORWARD, REAR OR ASSYMETRIC (AS KIT, TWO UNITS OF PLATES)		83,41	
BXB1020	<input type="checkbox"/>	2 CM SEAT HEIGHT INCREASED SEAT PLATE		94,79	
BACKREST OPTIONS					
BXB1040	<input type="checkbox"/>	HEADREST, SIDEWISE ADJUSTABLE	NC : 1047, 1060, 1070	◆	 1040  1060
BXB1060	<input type="checkbox"/>	HEADREST WITH CHEEK SUPPORT, SIDEWISE ADJUSTABLE	NC : 1047, 1070	○	
BXB1041	<input type="checkbox"/>	MATRX ELAN STANDARD PAD (254 mm / 10")	NC : 1050, 1070	○	 1070  1072
BXB1046	<input type="checkbox"/>	MATRX ELAN 4-POINT PAD (280W x 254H mm / 11"W x 10"H)	NC : 1050, 1070	408,53	
BXB1047	<input type="checkbox"/>	MATRX ELAN HARDWARE		○	 1041/ 1047
BXB1050	<input type="checkbox"/>	COVER FOR HEADREST	NC : 1060, 1070	47,39	
BXB1070	<input type="checkbox"/>	NECKREST		○	
BXB1090	<input type="checkbox"/>	HANDLES CLINIC KIT FOR HEAD-/NECKREST		30,33	
BXB1260	<input type="checkbox"/>	TILT SCALE, BACKREST RECLINE		16,11	

LEGREST OPTIONS				 1311 / 1312 / 1313
BXB1290	<input type="checkbox"/>	CALF STRAP (FOR FOOTREST ONE PIECE)	87,20	
BXB1300	<input type="checkbox"/>	FOOT PLATE PADDING	103,32	
BXB1310	<input type="checkbox"/>	CALF STRAP PADDED	126,07	
BXB1311	<input type="checkbox"/>	BODYPOINT ANKLE HUGGERS LARGE	MOUNTING KIT INCLUDED 170,62	
BXB1312	<input type="checkbox"/>	BODYPOINT ANKLE HUGGERS MEDIUM	MOUNTING KIT INCLUDED 170,62	
BXB1313	<input type="checkbox"/>	BODYPOINT ANKLE HUGGERS SMALL	MOUNTING KIT INCLUDED 161,14	
CHASSIS				
COLOUR STRAPS CHASSIS				
BXB1320	<input type="checkbox"/>	BLUE	◆	 1320 1330 1350 1340 1360
BXB1330	<input type="checkbox"/>	SILVER	○	
BXB1340	<input type="checkbox"/>	RED	○	
BXB1350	<input type="checkbox"/>	CHAMPAGNE	○	
BXB1360	<input type="checkbox"/>	PETROLIUM GREEN	○	
BXB1365	<input type="checkbox"/>	WITHOUT COLOUR STRAPS	○	
CASTOR ATTACHMENT TYPE				
BXB1370	<input type="checkbox"/>	FIXED	◆	
BXB1380	<input type="checkbox"/>	QR	75,83	
FRONT CASTORS				
BXB1395	<input type="checkbox"/>	4" x 1" - 100X27 BLACK SOFTROLL	○	
BXB1400	<input type="checkbox"/>	5" x 1" - 125X27 BLACK MEDIUM HARD	○	
BXB1435	<input type="checkbox"/>	6" x 1.1/4" - 150X30 BLACK MEDIUM HARD	◆	
BXB1455	<input type="checkbox"/>	8" x 1.1/4" - 200X30 BLACK SOLID TYRE	○	
BXB1465	<input type="checkbox"/>	8" x 1.1/4" - 200X32 PNEUMATIC BLACK	○	
BXB1475	<input type="checkbox"/>	8" x 2" - 200X45 BLACK SOLID TYRE	○	
REAR WHEELS				
REAR WHEELS SIZE				
BXB1510	<input type="checkbox"/>	20" / 515 MM - QUICK RELEASE ATTACHMENT	NC:1542, 1546, 1548, 1585, 1595, 1630 ○	
BXB1525	<input type="checkbox"/>	22" / 560 MM - QUICK RELEASE ATTACHMENT	NC : 1630 ○	
BXB1530	<input type="checkbox"/>	24" / 600 MM - QUICK RELEASE ATTACHMENT	◆	
REAR WHEELS TYPE				
BXB1542	<input type="checkbox"/>	STANDARD (BLACK HUB, COLORLESS RIM & ZINC PLATTED SPOKES)	NC : 1620, 1630 ◆	 Standard
BXB1544	<input type="checkbox"/>	REINFORCED (COLORLESS HUB, CLEAR ANODIZED RIM & STAINLESS STEEL SPOKES)	○	
BXB1546	<input type="checkbox"/>	DRUM BRAKE (22/24" : COLORLESS HUB, CLEAR ANODIZED RIM & STAINLESS STEEL SPOKES / 16" : BLACK PLASTIC HUB & RIM)	NC : 1595 213,27	
BXB1548	<input type="checkbox"/>	ONE ARM DRIVE (BLACK HUB & ZINC PLATTED SPOKED WITH ONE ARM DRIVE HANDRIM SYSTEM)	NC : 1565, 1610, 1620, 1630, 1670 ○	
TYRE TYPE				
BXB1565	<input type="checkbox"/>	PNEUMATIC PROFILED BLACK 1" 3/8	◆	 1" 1.3/8" 1.3/8" 1595 1565 1585
BXB1585	<input type="checkbox"/>	TYRES SOLID BLACK 1" 3/8	○	
BXB1595	<input type="checkbox"/>	PNEUMATIC LOW PROFILE BLACK 1"	○	
HANDRIM TYPE				
BXB1610	<input type="checkbox"/>	ALUMINIUM	◆	
BXB1620	<input type="checkbox"/>	PLASTIC COATED	200,00	
BXB1630	<input type="checkbox"/>	BRUSHED STAINLESS STEEL	196,21	
WHEEL OPTIONS				
SPOKEGUARD				
BXB1670	<input type="checkbox"/>	FROST	219,91	
SAFETY				
BXB1680	<input type="checkbox"/>	USER OPERATED TYRE BRAKES	◆	 1690
BXB1685	<input type="checkbox"/>	ONE ARM BRAKE LH	327,01	
BXB1687	<input type="checkbox"/>	ONE ARM BRAKE RH	327,01	
BXB1690	<input type="checkbox"/>	PELVIC BELT	73,93	 1691 / 1692
BXA1691	<input type="checkbox"/>	BODYPOINT 2 POINT CENTER-PULL PUSH-BUTTON MEDIUM	120,38	
BXA1692	<input type="checkbox"/>	BODYPOINT 2 POINT CENTER-PULL PUSH-BUTTON LARGE	127,01	 1693 / 1694
BXA1693	<input type="checkbox"/>	BODYPOINT 4 POINT CENTER-PULL PUSH-BUTTON MEDIUM	134,60	
BXA1694	<input type="checkbox"/>	BODYPOINT 4 POINT CENTER-PULL PUSH-BUTTON LARGE	142,18	
BXA1696	<input type="checkbox"/>	BODYPOINT PIVOTFIT HARNESS MEDIUM	ONLY WITH ELITE E2 /ELITE DEEP E2 BACKS OR WITH HEADREST / NECKREST 220,85	 1696 / 1697
BXA1697	<input type="checkbox"/>	BODYPOINT PIVOTFIT HARNESS LARGE	ONLY WITH ELITE E2 /ELITE DEEP E2 BACKS OR WITH HEADREST /NECKREST 227,49	

POSITIONING OPTIONS

Think of Bodypoint positioning accessories: belts, harnesses, ankle supports.



OPTIONS

TABLE TRAY

BXB1710	<input type="checkbox"/>	TABLE TRAY INCL MOUNTING KIT	NC : 1725	72,83
BXB1715	<input type="checkbox"/>	TABLE TRAY WITH ELBOW PADS	NC : 1725	154,50
BXB1716	<input type="checkbox"/>	HALF TABLE TRAY, CLEAR, FLIP UP, LH (ARMREST WITH STRAIGHT NARROW PAD INCL.)	NC : 1720	72,83
BXB1717	<input type="checkbox"/>	HALF TABLE TRAY, CLEAR, FLIP UP, RH (ARMREST WITH STRAIGHT NARROW PAD INCL.)	NC : 1720	72,83
BXB1730	<input type="checkbox"/>	SWING AWAY TABLE	NC : 1740	300,47
BXB1735	<input type="checkbox"/>	SWING AWAY TABLE WITH ELBOW PADS	NC : 1740	348,82

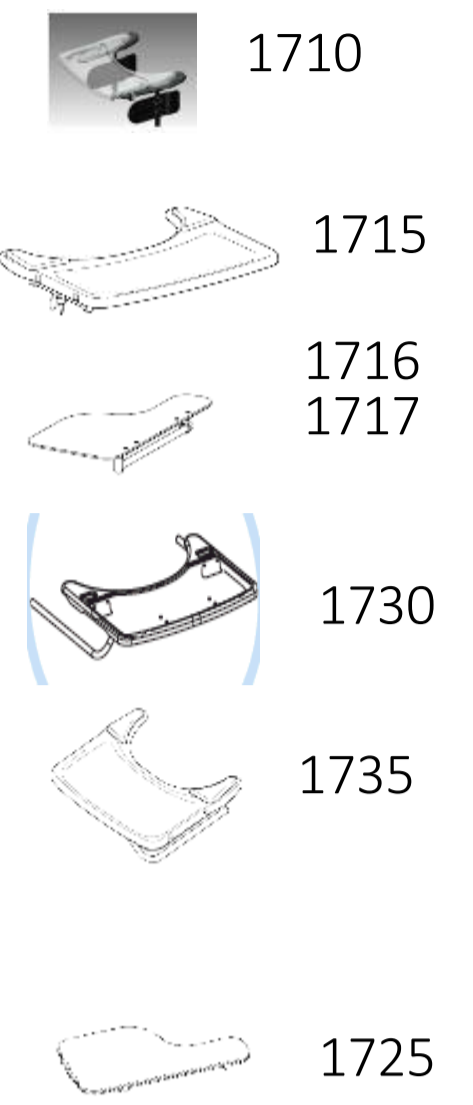
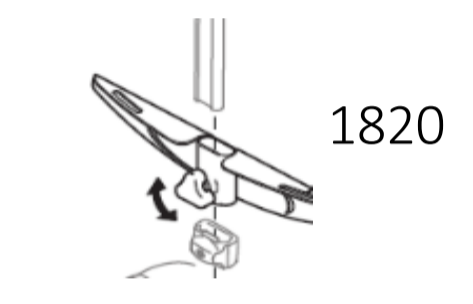

TABLE TRAY CUSHION

BXB1720	<input type="checkbox"/>	TABLE CUSHION	NC : 1730, 1735	104,27
BXB1725	<input type="checkbox"/>	PADDING	NC : 1730, 1735	90,05

OTHERS OPTIONS

BXB1740	<input type="checkbox"/>	LOCKING DEVICE FOR TABLE TRAY		59,72
BXB1770	<input type="checkbox"/>	MOUNTING BRACKET VIAMOBIL V25	NC : 1830, 1860	313,74
BXA1820	<input type="checkbox"/>	HARNESS ATTACHMENT BACKREST, UPPER		78,67
BXB1830	<input type="checkbox"/>	KERB LEVER	NC : 1860	75,83
BXB1850	<input type="checkbox"/>	TRANSPORTATION BRACKETS FOR OCCUPIED AND NON OCCUPIED TRANSPORT		52,13
BXB1860	<input type="checkbox"/>	VENTILATOR TRAY		599,05
BXB1880	<input type="checkbox"/>	DRIP STAND		105,21
BXB1890	<input type="checkbox"/>	RESTRICTOR KIT		○



COMPATIBILITY CHART: Seat height / rear wheel size / seat tilt

	REA Dahlia 45°			
	Seat Height	Rear wheel size	Seat tilt as delivered	Backrest recline as delivered
350mm	16"	45	30	
	20"	30	30	
380mm	16"	45	30	
	20"	45	10	
	22"	30	30	
400mm	20"	45	30	
430mm	20"	45	30	
	22"	45	30	
450mm	22"	45	30	
	24"	45	30	
480mm	16"	45	30	
	24"	45	30	
500mm	16"	45	30	

RAMPS

1440530	<input type="checkbox"/>	Fiberglass Folding Mono Ramp Folded dimensions: 2000 x 230 mm 16.3 kg - maximum capacity: 300 kg	1 787,68
1654128	<input type="checkbox"/>	Basic ramp 2 telescopic parts in aluminum and non-slip coating. Folded dimensions: 1210 x 194 mm. 8.8 kg per pair - maximum capacity: 270 kg	298,58
1654129	<input type="checkbox"/>	Quick2go Compact 3-part aluminum telescopic ramp with non-slip coating Folded dimensions: 870 x 237 mm 13.6 kg per pair - max. : 260 kg	559,24
1654130	<input type="checkbox"/>	Aluminium folding mono ramp Folded dimensions: 1824 x 714 mm 13.9 kg - maximum capacity: 300 kg	317,54

