

# Küschall® Compact Attract

Please contact Invacare EU Export Customer Services on :-  
**Tel : +33 247 626980 ; Email : serviceclient\_export@invacare.com**  
 Or visit our website : [www.invacare.eu.com](http://www.invacare.eu.com)



## küschall COMPACT Attract

Manual active chair in aluminum folding by brace



### Description:

- Single or double profiled crossbrace (depending on the width)
- Retractable and removable hangers
- **NEW frame colors**
- Matrix backrests and cushions available
- Compatible with twion, e-motion and e-Fix technologies
- Maximum user weight: 130kg

Date :

Purchase Order :

Customer Code :

Distributor Stamp :

We reserve the right to deliver a + or - tolerance of +/- 10 mm on all measurements We reserve the right to make technical changes without notice

Please make your selection with a cross in the box

◆ Standard feature

○ Free of charge option

CODE	DESCRIPTION	NC : Non Compatible NC : 9999 = not compatible with the reference 9999	Euros
DDY0020	<input type="checkbox"/> küschall® Compact Attract®		1589,55
DDY0022	<input type="checkbox"/> küschall® Compact Attract® Angle adjustable backrest	NC : Matrix	1716,54

**PRICES CUT!**

### SPECIAL CONSTRUCTION

DDY0000	<input type="checkbox"/> Myküschall special construction		On Request
UN	<input type="checkbox"/> Compact type folding backrest	(Select DDY0022, Special request)	256,87

### SEATING CHOICE

#### FRONT FRAME

DDY0211	<input type="checkbox"/> Standard		◆
<b>Seat width (SW)</b> (SW 360 to 420 mm: single cross / SW 440 to 500 mm: double cross)			
DDY0126	<input type="checkbox"/> 360 mm	DDY0128	<input type="checkbox"/> 380 mm
DDY0130	<input type="checkbox"/> 400 mm	DDY0132	<input type="checkbox"/> 420 mm
DDY0134	<input type="checkbox"/> 440 mm	DDY0136	<input type="checkbox"/> 460 mm
DDY0138	<input type="checkbox"/> 480 mm	DDY0140	<input type="checkbox"/> 500 mm
		NC: Matrix Elite backrests height 360 mm and all MX2	○

**Seat depth (SD)** (Chassis adjusted to seat depth from depth 380 mm (single cross) and from depth 400 mm (double cross) / Depth 360 and 380 mm: NC seat cushions Matrix seat, 95 mm center of gravity position and pull brakes

DDY0412	<input type="checkbox"/> 360 mm	DDY0415	<input type="checkbox"/> 380 mm	○
DDY0417	<input type="checkbox"/> 400 mm			◆
DDY0420	<input type="checkbox"/> 420 mm	DDY0422	<input type="checkbox"/> 440 mm	○
DDY0424	<input type="checkbox"/> 460 mm	DDY0427	<input type="checkbox"/> 480 mm	○
DDY0428	<input type="checkbox"/> 500 mm			○

#### BACK HEIGHT (BH)

DDY0585	<input type="checkbox"/> Backrest height according to chosen Matrix backrest	(NC : 0705, 0720, 0700, 0725, 0735 )	○	
DDY0506	<input type="checkbox"/> 330 mm	DDY0509	<input type="checkbox"/> 345 mm	○
DDY0512	<input type="checkbox"/> 360 mm	DDY0514	<input type="checkbox"/> 375 mm	○
DDY0516	<input type="checkbox"/> 390 mm	DDY0518	<input type="checkbox"/> 405 mm	○
DDY0520	<input type="checkbox"/> 420 mm			◆
DDY0522	<input type="checkbox"/> 435 mm	DDY0524	<input type="checkbox"/> 450 mm	○
DDY0526	<input type="checkbox"/> 465 mm	DDY0528	<input type="checkbox"/> 480 mm	○
DDY0530	<input type="checkbox"/> 495 mm			○

**Front Seat Height (FSTF)** (FSTF 430 mm to 450 mm: high mounted forks with 5" wheels / FSTF 450 to 470 mm: high mounted forks with 6" wheels / FSTF 480 to 500 mm: high mounted forks with 7" wheels) FSTF 450, 460 and 470 mm: NC 7" wheels

DDY0845	<input type="checkbox"/> 430 mm	DDY0846	<input type="checkbox"/> 440 mm	NC: 6" and 7" wheels	○
DDY0847	<input type="checkbox"/> 450 mm	DDY0848	<input type="checkbox"/> 460 mm		○
DDY0849	<input type="checkbox"/> 470 mm	DDY0850	<input type="checkbox"/> 480 mm		○
DDY0851	<input type="checkbox"/> 490 mm				○
DDY0852	<input type="checkbox"/> 500 mm				◆
DDY0853	<input type="checkbox"/> 510 mm	DDY0854	<input type="checkbox"/> 520 mm		○

**Rear seat height (RSTF)** (RSTF 400 mm NC fixed mudguards) /FSTF-RSTF: maximum 80 mm / With stems at 70°: RFST max = FSTF-0 mm

DDY0945	<input type="checkbox"/> 400 mm	DDY0946	<input type="checkbox"/> 410 mm	NC: armrests 1440 and 1441	○
DDY0947	<input type="checkbox"/> 420 mm	DDY0948	<input type="checkbox"/> 430 mm		○
DDY0949	<input type="checkbox"/> 440 mm				◆
DDY0950	<input type="checkbox"/> 450 mm				○
DDY0951	<input type="checkbox"/> 460 mm	DDY0952	<input type="checkbox"/> 470 mm		○
DDY0953	<input type="checkbox"/> 480 mm	DDY0954	<input type="checkbox"/> 490 mm		○

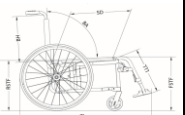
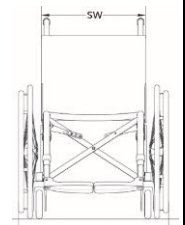

Front wheel / Front wheel attachment	High mounted	Standard mounted
5"	430 - 450	460 - 520
6"	450 - 470	480 - 520
7"	480 - 500	510 - 520

LOWER LEG LENGTH (LLL) 70° LEGREST: LLL MAX = "FSTF-20 MM" ; 90° LEGREST: LLL MAX = "FSTF-30 MM"						
DDY1679	<input type="checkbox"/>	380 mm	DDY1680	<input type="checkbox"/>	390 mm	○
DDY1681	<input type="checkbox"/>	400 mm	DDY1682	<input type="checkbox"/>	410 mm	○
DDY1683	<input type="checkbox"/>	420 mm				○
DDY1684	<input type="checkbox"/>	430 mm				◆
DDY1685	<input type="checkbox"/>	440 mm	DDY1686	<input type="checkbox"/>	450 mm	○
DDY1687	<input type="checkbox"/>	460 mm				○
NC: 90° stems for LLL450 mm (NC: 1542, 1573 )						
BACKREST CHOICE						
Type de dossier						
DDY0705	<input type="checkbox"/>	LUMBAL TUBES			(NC : All MatrX Backrests )	43,60
Backrest Angle (BA) (in relation to the seat), only for angle-adjustable backrest. For 82° angle, only possible with FSTF-RSTF = 80 mm						
DDY0707	<input type="checkbox"/>	82°	DDY0719	<input type="checkbox"/>	94°	○
DDY0718	<input type="checkbox"/>	86°	DDY0711	<input type="checkbox"/>	98°	○
DDY0709	<input type="checkbox"/>	90°	DDY0712	<input type="checkbox"/>	102°	○
BACK UPHOLSTERY						
DDY0700	<input type="checkbox"/>	STANDARD UPHOLSTERY			(NC : All MatrX Backrests, 0703, 1491 )	◆
DDY0725	<input type="checkbox"/>	TENSION ADJUSTABLE BACK BLACK COVER WITH LOOP BANDS			(NC : All MatrX Backrests )	33,08
DDY0735	<input type="checkbox"/>	AERO BACK, TENSION ADJUSTABLE WITH LOOP BANDS			(NC : All MatrX Backrests )	235,07
BACKREST UPHOSTERY CUSTOMIZATION						
UN1680967	<input type="checkbox"/>	COLORED BACKREST UPHOLSTERY (20 colors to choose from)☒				287,00
UN1680968	<input type="checkbox"/>	COLORED SLEEVES (20 colors to choose from)☒				787,00
MATRX BACKREST - HEIGHT REFERS TO ACTUAL HEIGHT OF THE MATRX BACKREST, REQUIRES ADDITIONAL LEAD TIME						
DDY0764	<input type="checkbox"/>	MATRX MX2, HEIGHT 150 MM WITH QUICK RELEASE HARDWARE			NC: width 480 and 500 mm, 1720	927,01
DDY0765	<input type="checkbox"/>	MATRX MX2, HEIGHT 230 MM WITH QUICK RELEASE HARDWARE			NC: width 480 and 500 mm, 1720	927,01
DDY0766	<input type="checkbox"/>	MATRX MX2, HEIGHT 305 MM WITH QUICK RELEASE HARDWARE			NC: width 480 and 500 mm, 1720	927,01
DDY0767	<input type="checkbox"/>	MATRX MX2, HEIGHT 405 MM WITH QUICK RELEASE HARDWARE			NC: width 480 and 500 mm	927,01
DDY0758	<input type="checkbox"/>	ELITE STANDARD E2, HEIGHT 260 MM WITH EASY-SET MOUNTING HARDWARE			NC : 1720	717,54
DDY0759	<input type="checkbox"/>	ELITE STANDARD E2, HEIGHT 310 MM WITH EASY-SET MOUNTING HARDWARE			NC : 1720	717,54
DDY0760	<input type="checkbox"/>	ELITE STANDARD E2, HEIGHT 360 MM WITH EASY-SET MOUNTING HARDWARE			NC: width 480 and 500 mm, 1720	717,54
DDY0761	<input type="checkbox"/>	ELITE STANDARD E2, 410 MM WITH EASY-SET MOUNTING HARDWARE				717,54
DDY0763	<input type="checkbox"/>	ELITE STANDARD E2, 460 MM WITH EASY-SET MOUNTING HARDWARE				717,54
DDY0756	<input type="checkbox"/>	ELITE DEEP E2, HEIGHT 310 MM WITH EASY-SET MOUNTING HARDWARE			NC : 1720	717,54
DDY0757	<input type="checkbox"/>	ELITE DEEP E2, 410 MM WITH EASY-SET MOUNTING HARDWARE				717,54
DDY0762	<input type="checkbox"/>	ELITE DEEP E2, 460 MM WITH EASY-SET MOUNTING HARDWARE				717,54
PUSH HANDLES						
DDY0702	<input type="checkbox"/>	PUSH HANDLES FIXED, LONG				◆
DDY0750	<input type="checkbox"/>	WITHOUT PUSH HANDLES			(NC : 0923 )	○
DDY0751	<input type="checkbox"/>	PUSH HANDLES FIXED, MINI			(NC : 0923 )	○
DDY0703	<input type="checkbox"/>	HEIGHT ADJUSTABLE REAR SET			(NC: 1411 )	192,42
DDY0733	<input type="checkbox"/>	HEIGHT ADJUSTABLE, INTEGRATED			(NC: 1491 )	232,23
DDY0704	<input type="checkbox"/>	FOLDABLE PUSH HANDLES			(NC : 1491 , 0923 )	192,42
BACKREST OPTION						
BACKREST OPTION						
DDY1491	<input type="checkbox"/>	BACKREST STABILIZATION BAR, SWING AWAY AND REMOVABLE				138,39



0700



0764, 0765, 0766, 0767

MX2: only 140g more than a tension-adjustable backrest!



0758, 0759, 0760, 0761, 0763















0756, 0757, 0762



0703

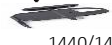

1491

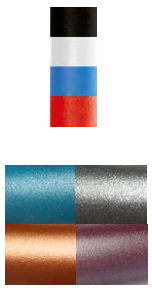
SEATING					
<b>SEAT UPHOLSTERY</b>					
DDY0611	<input type="checkbox"/>	STANDARD SEAT UPHOLSTERY WITH 1 CENTRAL LOOP BAND (SOFT)		◆	 0611
<b>SEAT UPHOLSTERY CUSTOMIZATION</b>					
UN1680966	<input type="checkbox"/>	COLORED SEAT UPHOLSTERY (20 colors to choose from)		◆	 0611
<b>SEAT CUSHION</b>					
DDY0600	<input type="checkbox"/>	STANDARD SEAT CUSHION, 60 MM DOUBLE FOAM WITH VISCO TOP		101,42	 0600
DDY0662	<input type="checkbox"/>	MATRX LIBRA CUSHION, BLACK SMOOTH COVER	NOT POSSIBLE WITH SW ≤ 340 MM & SD ≤ 380 MM SW 360 MM ONLY POSSIBLE WITH SD 400/420 MM	293,84	 0606
<b>SEAT OPTION</b>					
DDY0606	<input type="checkbox"/>	SEAT BAG, CLICK IN AND REMOVABLE		74,88	 0662
<b>SEAT UPHOLSTERY BAG</b>					
DDY0616	<input type="checkbox"/>	SMALL BAGS		56,87	
DDY0617	<input type="checkbox"/>	BIG BAG		56,87	0616/0617
<b>LEGREST / FOOTREST</b>					
<b>LEGREST</b>					
DDY1540	<input type="checkbox"/>	LEGREST, ANGLE OPEN, 70°		◆	
DDY1542	<input type="checkbox"/>	LEGREST, ANGLE CLOSED, 90°	NC : LL 450 / 460 mm, 1563, 0821, 0820, 0822	○	
<b>FOOTREST</b>					
DDY1562	<input type="checkbox"/>	2 PC. PLASTIC, SET TO THE FRONT		◆	 1562/1563
DDY1563	<input type="checkbox"/>	2 PC. PLASTIC, SET TO THE BACK BLACK		○	
DDY1573	<input type="checkbox"/>	2 PC. ANGLE ADJUSTABLE - CAN BE ADJUSTED TO FRONT OR REAR		175,36	
<b>CALF STRAP / HEEL LOOPS</b>					
DDY1534	<input type="checkbox"/>	CALF STRAP		66,35	
DDY1530	<input type="checkbox"/>	HEEL LOOPS		◆	1530
<b>SIDE GUARDS</b>					
<b>SIDEGUARDS CLOTHGUARDS</b>					
DDY1424	<input type="checkbox"/>	COMPOSITE CLOTHES GUARDS		◆	
DDY1401	<input type="checkbox"/>	CARBON CLOTHES GUARDS		223,70	
DDY1426	<input type="checkbox"/>	COMPOSITE MUDGUARDS, FIXED	NOT POSSIBLE WITH RSTF 400 MM	○	 1408
DDY1425	<input type="checkbox"/>	ECONOMY MUD GUARDS, REMOVABLE		71,09	
DDY1405	<input type="checkbox"/>	MUD GUARDS CARBON, FIXED	NOT POSSIBLE WITH RSTF 400 MM	190,52	
DDY1408	<input type="checkbox"/>	MUD GUARDS CARBON, REMOVABLE		295,73	
<b>SIDEREST</b>					
DDY1416	<input type="checkbox"/>	SIDEREST HEIGHT ADJUSTABLE (WITH TOOLS), REMOVABLE, SHORT, NON-LOCKING	NOT POSSIBLE WITH PUSH HANDLES HEIGHT ADJUSTABLE REAR SET	○	 1416/1421
DDY1421	<input type="checkbox"/>	SIDEREST HEIGHT ADJUSTABLE (WITH TOOLS), REMOVABLE, LONG, NON-LOCKING	NOT POSSIBLE WITH PUSH HANDLES HEIGHT ADJUSTABLE REAR SET	24,64	
DDY1440	<input type="checkbox"/>	SIDEREST WITH DESK FUNCTION, FLIP-BACK, HEIGHT ADJUSTABLE, REMOVABLE, SHORT	(NC: 1411, 0283, 1760)	217,06	1440/1441
DDY1441	<input type="checkbox"/>	SIDEREST WITH DESK FUNCTION, FLIP-BACK, HEIGHT ADJUSTABLE, REMOVABLE, LONG	(NC: 1411, 0283, 1760)	240,76	 1445
DDY1445	<input type="checkbox"/>	KÜSCHALL ARMREST, BLACK CONTOUR, LOCKING, HEIGHT ADJUSTABLE, REMOVABLE, SWING-AWAY, FLIP-BACK, COMFORT PADDED WITH NEW ARMPAD	(NC: 1411, 0283)	339,34	
<b>ARMREST</b>					
DDY1411	<input type="checkbox"/>	TUBULAR ARMREST, NON-LOCKING, HEIGHT ADJUSTABLE, REMOVABLE, SWING-AWAY, COMFORT PADDED	(NC : 0926)	264,45	 1411
<b>FRAME COLOUR</b>					
<b>FRONT FRAME COLOUR, BACK FRAME AND CROSS-BRACE IN ATTRACT BLACK, FRONT FRAME AND LEGRESTS IN SELECTED COLOUR</b>					
DDY0360	<input type="checkbox"/>	ATTRACT BLACK		◆	
DDY0307	<input type="checkbox"/>	ATTRACT GREY		○	
DDY0308	<input type="checkbox"/>	ATTRACT BLUE		○	
DDY0311	<input type="checkbox"/>	ATTRACT BLUE		○	
UN1680972	<input type="checkbox"/>	COOPER	NEW	○	
UN1680971	<input type="checkbox"/>	DEEP LAGOON BLUE	NEW	○	
UN1680970	<input type="checkbox"/>	IRON GREY	NEW	○	
UN1680966	<input type="checkbox"/>	PLUM PURPLE	NEW	○	
	<input type="checkbox"/>	Other küschall colors (except fluo and polished varnish) - a Unique special manufacturing solution, price for two-tone chassis (+ 5 days)		473,93	

FRONT WHEEL				
DDY0810	<input type="checkbox"/>	5" EVERYDAY WITH BLACK TYRE		○
DDY0863	<input type="checkbox"/>	5" COMFORT WHEEL BLACK TYRE		◆
UN1680964	<input type="checkbox"/>	5" COLORED FROGLGS		285,31
DDY0821	<input type="checkbox"/>	6" PNEUMATIC WHEEL		36,02
DDY0820	<input type="checkbox"/>	6" COMFORT WITH BLACK TYRE		○
DDY0822	<input type="checkbox"/>	7" COMFORT WITH BLACK TYRE		36,02
<b>BEARINGS</b>				
UN1673803	<input type="checkbox"/>	CERAMIC OR ANODIZED BEARINGS FOR 4" OR 5" FRONT WHEELS		97,63
REAR WHEEL CHOICE				
REAR WHEEL POSITION				
DDY0264	<input type="checkbox"/>	2ND POSITION	NC : SD 360/ 380 mm	○
DDY0265	<input type="checkbox"/>	3RD POSITION		◆
DDY0266	<input type="checkbox"/>	4TH POSITION	(NC : 0926 )	○
REAR WHEEL SIZE				
DDY0902	<input type="checkbox"/>	24"		◆
REAR WHEEL CAMBER				
DDY0282	<input type="checkbox"/>	0°		◆
DDY0283	<input type="checkbox"/>	3°	(NC : 0926, 0923 )	○
REAR WHEEL TYPE				
DDY0921	<input type="checkbox"/>	24" ACTIVE WHEELS (BLACK RIM, HUB AND RADIAL SPOKING INCL. ALU HANDRIMS)	(NC : All Handrim, 1200 )	◆
DDY0915	<input type="checkbox"/>	KUSCHALL STAREC HUB (BLACK RIM AND HUB, BLACK CROSS SPOKING)		108,06
DDY0908	<input type="checkbox"/>	HIGH PERFORMANCE (BLACK RIM, BLACK STAREC HUB, BLACK CROSS SPOKING)	(NC : 1004)	471,09
DDY0906	<input type="checkbox"/>	SPINERGY LXX (BLACK RIM, HUB AND RADIAL SPOKING)	(NC : 1004)	711,85
DDY0923	<input type="checkbox"/>	24" WHEELS WITH ATTENDANT DRUM BRAKE	(NC : Alber, 0926)	472,04
UN1680962	<input type="checkbox"/>	SPINERGY LITE EXTREME X-LACED XLX 24", black, silver hub. If customized, black hub".		1120,38
SPINERGY REAR WHEEL CUSTOMIZATION				
UN1676528	<input type="checkbox"/>	SPINERGY REAR WHEEL RIM COLOR CUSTOMIZATION		354,50
UN1676529	<input type="checkbox"/>	SPINERGY REAR WHEEL HUB COLOR CUSTOMIZATION		354,50
UN1676530	<input type="checkbox"/>	SPINERGY REAR WHEEL SPOKES COLOR CUSTOMIZATION		162,09
ALBER ADDS ON KIT, 2 ANTITIPPERS FROM ALBER NEEDS TO BE INSTALLED WITH THIS OPTION				
DDY0926	<input type="checkbox"/>	TWION AND E-MOTION M25 ADAPTER PLATE, 2 ALBER ANTITIPPERS INCLUDED	(NC: All Anti-tippers, All Tipper Aids, All Cane Holder )	579,15
<i>Tip : for perfect compatibility of the brakes with the manual wheels, we advise you to equip them with the same coating as the motorized wheels.</i>				
REAR WHEEL TYRE				
DDY1014	<input type="checkbox"/>	MAXXIS LITE GUARD BLACK TYRE (puncture protection)	24"	◆
DDY1004	<input type="checkbox"/>	24" SOLID TYRE	24"	○
DDY1008	<input type="checkbox"/>	MAXXIS ALPHA PROTECT BLACK TYRE (puncture protection)	24"	72,04
DDY1011	<input type="checkbox"/>	24" MBL SPEEDLITE	24"	72,04
HANDRIM				
DDY1113	<input type="checkbox"/>	24" LIGHT ALU, GREY, DIST. 3 CM		◆
DDY1102	<input type="checkbox"/>	24" SUPERGRIPP, DIST. 3 ADJUSTABLE 4CM		142,18
DDY1104	<input type="checkbox"/>	24" STEEL POLISHED, DIST. 3 CM		103,32
DDY1106	<input type="checkbox"/>	24" TITANIUM, DIST. 3 CM		277,73
DDY1120	<input type="checkbox"/>	24" CARBOLIFE GEKKO S, WITH ANTI-SLIP DIST. 3 CM ADJUSTABLE 4CM		277,73
Anodizing kit				
UN1676887	<input type="checkbox"/>	Anodizing kit 3		779,15
SPOKE GUARDS				
DDY1200	<input type="checkbox"/>	24" TRANSPARENT		181,99



0810

**Tyre size**  
**MAXXIS LIGHT GUARD / ALPHA PROTECT :**  
 24" : 25-540  
**MBL SPEEDLITE :**  
 24" : 25-540



1014 1008



1011

SAFETY				
<b>BRAKE</b>				
DDY1311	<input type="checkbox"/>	ATTRACT PULL BRAKES	(NC : 1310 )	○
DDY1312	<input type="checkbox"/>	ATTRACT PUSH BRAKES	(NC : 1310 )	◆
DDY1306	<input type="checkbox"/>	PULL BRAKES		70,14
<b>ANTITIPPER</b>				
DDY1702	<input type="checkbox"/>	ANTITIPPER RIGHT		121,33
DDY1703	<input type="checkbox"/>	ANTITIPPER LEFT		121,33
DDY1704	<input type="checkbox"/>	ANTITIPPER BOTH SIDES		242,65
<b>POSTURE BELT</b>				
DDY1720	<input type="checkbox"/>	TRANSPORTATION KIT (LABELS)		24,64
<b>POSTURE BELT</b>				
DDY1730	<input type="checkbox"/>	POSTURE BELT - PLASTIC BUCKLE		32,23
<b>PASSIVE LIGHTS</b>				
DDY1710	<input type="checkbox"/>	PASSIVE LIGHTS ASSEMBLED (MOUNTED ON SPOKES)		○



1702/1703

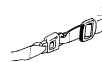

1730

ACCESSORIES				
DDY1729	<input type="checkbox"/>	REAR FRAME PROTECTION		40,76
<b>TIPPER AID, NOT POSSIBLE WITH ALBER ADDS-ON</b>				
DDY1708	<input type="checkbox"/>	TIPPER-AID, RIGHT	(NC : 1706, 1719 )	66,35
DDY1709	<input type="checkbox"/>	TIPPER-AID, LEFT	(NC: 1707, 1719 )	66,35
DDY1718	<input type="checkbox"/>	TIPPER-AID, BOTH SIDES	(NC: 1706, 1707, 1719 )	132,70
<b>CANE HOLDER, NOT POSSIBLE WITH ALBER ADDS-ON</b>				
DDY1706	<input type="checkbox"/>	CANE HOLDER, RIGHT		81,52
DDY1707	<input type="checkbox"/>	CANE HOLDER, LEFT		81,52
DDY1719	<input type="checkbox"/>	CANE HOLDER, BOTH SIDES		163,03
<b>KUSCHALL WATCH</b>				
DDY1712	<input type="checkbox"/>	KÜSCHALL WATCH, RIGHT SIDE		174,41
DDY1713	<input type="checkbox"/>	KÜSCHALL WATCH, LEFT SIDE		174,41
<b>Autres</b>				
DDY1760	<input type="checkbox"/>	THERAPY TABLE	NC WITH CLOTHES-GUARDS (DDY1424/1401) NC WITH MUDGUARDS (DDY1425/1426/1408/1405) NC WITH ARMRESTS WITH DESK FUNCTION (DDY1440/1441)	355,45
DDY1715	<input type="checkbox"/>	AIR PUMP		24,64
DDY1717	<input type="checkbox"/>	TOOL KIT		11,37
DDY1728	<input type="checkbox"/>	WHEELS BAG (FOR 22", 24" AND 26" REAR WHEELS)		60,66

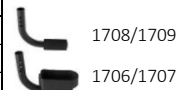

1708/1709

1706/1707



1717



1712/1713



1728

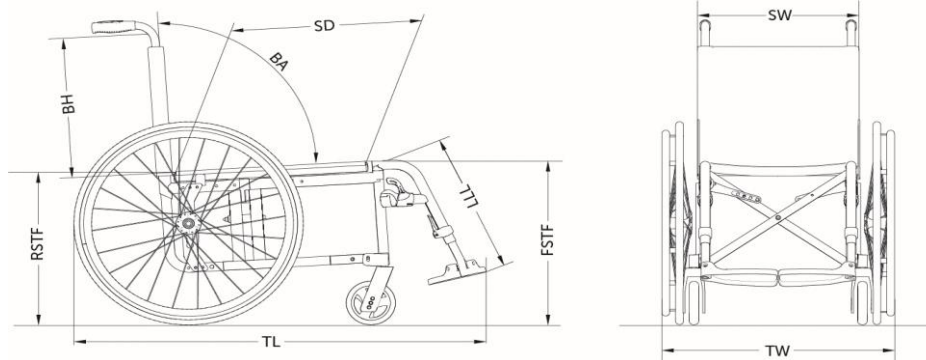

RAMPS				
1654128	<input type="checkbox"/>	Basic ramp 2 telescopic parts in aluminum and non-slip coating. Folded dimensions: 1210 x 194 mm 8.8 kg per pair - maximum capacity: 270 kg		402,84
1654129	<input type="checkbox"/>	Quick2go Compact 3-part aluminum telescopic ramp with non-slip coating. Folded dimensions: 870 x 237 mm 13.6 kg per pair - maximum capacity: 260 kg		805,69
1654130	<input type="checkbox"/>	Aluminum Folding Mono Ramp Folded dimensions: 1824 x 714 mm 13.9 kg - maximum capacity: 300 kg		426,54



1654128



1654129



1654130