

Invacare® Action³ NG Hemi

Please contact Invacare EU Export Customer Services on :-
Tel : +33 247 626980 ; Email : serviceclient_export@invacare.com
Or visit our website : www.invacare.eu.com



Invacare® Action³ NG Hemi

Folding aluminum manual wheelchair



Description:

- Weight: from 15.2 kg.
- Maximum user weight: 125 kg.
- Equipped as standard with a concave armrest for hemiplegic patients
- Double handrail available as an option
- Seat height from 360 mm for foot traction
- 2-year warranty period excluding wear parts

Date :

Purchase Order :

Customer Code :

Distributor Stamp:



Invacare Unique Customization Service
Please specify the quote or special production number:

Please make your selection with a cross in the box

◆ Standard feature

○ Free of charge option

CODE	DESCRIPTION	NC : Non Compatible NC : 9999 = not compatible with the reference 9999	EUROS	
CEP0031	<input type="checkbox"/> Invacare® Action®3NG Hemi - Fixed backrest and 1 concave Hemi Armrest (refer to the armrests section)		643,01	
CEP0036	<input type="checkbox"/> Invacare® Action®3NG Hemi - Mid-height folding backrest and 1 Hemi Armrest concave (refer to the armrests section)		685,35	
CEP0041	<input type="checkbox"/> Invacare® Action®3NG Hemi - Reclining backrest and 1 Hemi concave armrest (refer to the armrests section)		685,35	
ALBER				
CEP0080	<input type="checkbox"/> BRACKET FOR VIAMOBIL V25	NC : 0140, 0150, 0300, 0310, 0315, 0455, 0460, 0451 to, 0469, 1170, 1201, 1365, 1370, 1375, 1430, 1440	313,74	
CEP0090	<input type="checkbox"/> BRACKET FOR VIAMOBIL ECO V14	NC : 0140, 0150, 0290, 0300, 0310, 0315, 0451 to 0469, 0905, 0906, 0907, 0908, 0945, 1185, 1201, 1365, 1370, 1375, 1430, 1440, 1451	414,25	
PROPULSION TYPE				
CEP0100	<input type="checkbox"/> SELF PROPULSION	NC : 1075	◆	
CEP0140	<input type="checkbox"/> DUAL HANDRIM RIGHT HAND PROPULSION (NEW DHR SYSTEM), QR AXLE	NC : 0315, right gutter armrest, 1064, 1071, 1072, 1073, 1074, 1140, 1150, 1170, 1185, 1260, 1261, 1280, 1330, 1365	257,09	
CEP0150	<input type="checkbox"/> DUAL HANDRIM LEFT HAND PROPULSION (NEW DHR SYSTEM), QR AXLE	NC : 0315, left gutter armrest, 1064, 1071, 1072, 1073, 1074, 1140, 1150, 1170, 1185, 1260, 1261, 1280, 1320, 1365	257,09	
SEAT				
SEAT WIDTH				
CEP0180	<input type="checkbox"/> 380 mm	NC : 0485, 0486, 0487, 0488, 0545+0595, 0852, 0855	○	
CEP0190	<input type="checkbox"/> 405 mm	NC : 0482, 0486, 0487, 0488, 0545+0595	○	
CEP0200	<input type="checkbox"/> 430 mm	NC : 0482, 0483, 0487, 0488, 0853	◆	
CEP0210	<input type="checkbox"/> 455 mm	NC : 0482, 0483, 0484, 0488, 0853	○	
CEP0220	<input type="checkbox"/> 480 mm	NC : 0482, 0483, 0484, 0485, 0853, 0854	○	
CEP0230	<input type="checkbox"/> 505 mm	NC : 0842, 0483, 0484, 0485, 0486, 0853, 0854, 0855, 0856	○	

SEAT DEPTH				
CEP0240	<input type="checkbox"/>	400 mm	NC : 0879	◆
CEP0250	<input type="checkbox"/>	450 mm	NC : 0853, 0878	○
CEP0252	<input type="checkbox"/>	400 TO 450 MM ADJUSTABLE SEAT DEPTH	NC : 0330, 0350	30,33
SEAT HEIGHT				
CEP0260	<input type="checkbox"/>	510 mm	NC : 1050, 1054, 1056, 1066	○
CEP0270	<input type="checkbox"/>	485 mm	NC : 1054	○
CEP0280	<input type="checkbox"/>	460 mm		◆
CEP0290	<input type="checkbox"/>	435 mm	NC : 0660/0670/0760/0770 + 24" wheels, 1005, 1010, 1030	○
CEP0300	<input type="checkbox"/>	410 mm	NC : 24" wheels, 0935, 1005, 1010, 1030, 1035, 1056, 1068, 1365, 1370, 1440	○
CEP0310	<input type="checkbox"/>	385 mm	NC : 0660, 0670, 0760, 0770, 0935, 1005, 1035, 1056, 1068, 1073, 1280, 1365, 1370, 1440	○
CEP0315	<input type="checkbox"/>	360 MM SEAT HEIGHT, 0° SEAT ANGLE (AVAILABLE WITH LOW FORK, 5" FRONT WHEEL & 20" REAR WHEELS)	NC : 0600, 0611, 0620, 0660, 0670, 0760, 0770, 0935, 1280, 1365, 1375, 1440	145,02
SEAT UPHOLSTERY TYPE				
CEP0330	<input type="checkbox"/>	NYLON WITHOUT LOOP BANDS SEAT UPHOLSTERY		◆
CEP0340	<input type="checkbox"/>	NYLON WITH LOOP BANDS SEAT UPHOLSTERY		○
CEP0350	<input type="checkbox"/>	PADDED NYLON SEAT UPHOLSTERY		30,33
BACKREST				
BACKREST TYPE - Anti-tippers required with reclining backrests				
CEP0380	<input type="checkbox"/>	FIXED 0° BACKREST 2 HEIGHTS 400/430 MM (DELIV. 430 MM)	NC : 0471, 0477, 0945	52,13
CEP0390	<input type="checkbox"/>	FIXED 0° BACKREST 510 MM HEIGHT - FIXED PUSH HANDLES	NC : 0471, 0477, 0945	86,26
CEP0395	<input type="checkbox"/>	FIXED 7° BACKREST - HEIGHT ADJUST 380 TO 460 MM (DELIVERED 380 MM)	NC : 0451 to 0469, 0474, 0475, 0477, 0478, 0479, 0481, 0905, 0906, 0907, 0940, 1451	295,73
CEP0396	<input type="checkbox"/>	FIXED 7° BACKREST - HEIGHT ADJUST 380 TO 460 MM (DELIVERED 380 MM)	NC : 0451 to 0469, 0474, 0475, 0477, 0478, 0479, 0481, 0905, 0906, 0907, 0940, 1451	295,73
CEP0410	<input type="checkbox"/>	FIXED 7° BACKREST - 2 HEIGHTS 400/430 MM (DELIV. 430 MM)	NC : 0471, 0477, 0945	◆
CEP0420	<input type="checkbox"/>	FIXED 7° BACKREST - 510 MM HEIGHT	NC : 0471, 0477, 0945	33,18
CEP431	<input type="checkbox"/>	ANGLE ADJUSTABLE AND FOLD DOWN (-15° to + 15°) FIXED 7°, HEIGHT 350MM / 14" WITH FIXED SHORT PUSHHANDLES - HEIGHT 325-350 MM / 13"-14" SET AT 350MM / 14" (2 positions, 25mm / 1" steps through uph)	NC : 0471, 0474, 0475, 0478, 0479, 0480, 0481, 0882, 0905, 0906, 0907, 0940, 1280, 1345, 1451	456,87
CEP0432	<input type="checkbox"/>	ANGLE ADJUSTABLE AND FOLD DOWN (-15° to + 15°) FIXED 7°, HEIGHT 425MM / 17" WITH FIXED LONG PUSHHANDLES - HEIGHT 425-450 MM / 17"-18" SET AT 425MM / 17" (2 positions, 25mm / 1" steps through uph)	NC : 0471, 0474, 0475, 0478, 0479, 0480, 0481, 0882	456,87
CEP0435	<input type="checkbox"/>	RECLINING (RATCHET) 0/30° BACKREST INCL. BACKRACE & PASSIVE REAR WHEEL POS. ONLY - 3 HEIGHTS 390/410/430 MM (DELIV.430 MM)	NC : 0471, 0477, 0940, 0945, 1185, 1190	◆
CEP0445	<input type="checkbox"/>	RECLINING (GAS SPRING) 0/30° BACKREST INCL. BACKRACE & PASSIVE REAR WHEEL POS. ONLY - 3 HEIGHTS 390/410/430 MM (DELIV.430 MM)	NC : 0471, 0477, 0940, 0945, 1185, 1190	○
CEP0450	<input type="checkbox"/>	RECLINING (GAS SPRING) 0/30° BACKREST INCL. BACKRACE & PASSIVE REAR WHEEL POS. ONLY - 3 HEIGHTS470/490/510 MM (DELIV.510 MM)	NC : 0471, 0477, 0940, 0945, 1185, 1190	33,18
CEP0455	<input type="checkbox"/>	FOLDING 7° BACKREST - 430 MM HEIGHT	NC : 0451 to 0454, 0458 to 0467, 0471, 0477, 0945	◆
CEP0460	<input type="checkbox"/>	FOLDING 7° BACKREST - 510 MM HEIGHT	NC : 0451 to 0454, 0458 to 0467, 0471, 0477, 0480, 0481, 0945	33,18



0396



0435

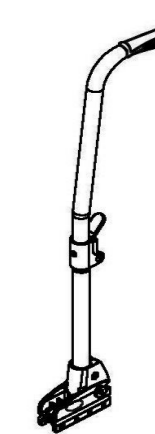

0455 / 0460

Matrx backs - See correspondence table "Possible widths of Matrx backs depending on the width of the seat" at the bottom of the order form. Find the trunk supports and all the accessories on the Matrx order form!

CEP0451	<input type="checkbox"/>	MATRX ELITE E2 BACK WITH HARDWARE - 160 MM BACK HEIGHT - CURVED 80 MM - MINI FASTENERS	NC : 0471, 0474, 0475, 0477, 0478, 0479, 0480, 0481, 0657, 0677, 0757, 0777, 0882, 0940, 0945	717,54
CEP0452	<input type="checkbox"/>	MATRX ELITE E2 BACK WITH HARDWARE - 210 MM BACK HEIGHT - CURVED 80 MM - MINI FASTENERS	NC : 0471, 0474, 0475, 0477, 0478, 0479, 0480, 0481, 0657, 0677, 0757, 0777, 0882, 0940, 0945	717,54
CEP0453	<input type="checkbox"/>	MATRX ELITE E2 BACK WITH HARDWARE - 260 MM BACK HEIGHT - CURVED 80 MM - MINI FASTENERS	NC : 0471, 0474, 0475, 0477, 0478, 0479, 0480, 0481, 0657, 0677, 0757, 0777, 0882, 0940, 0945	717,54
CEP0454	<input type="checkbox"/>	MATRX ELITE E2 BACK WITH HARDWARE - 310 MM BACK HEIGHT - CURVED 80 MM - MINI FASTENERS	NC : 0471, 0474, 0475, 0477, 0478, 0479, 0480, 0481, 0657, 0677, 0757, 0777, 0882, 0940, 0945	717,54
CEP0456	<input type="checkbox"/>	MATRX ELITE E2 BACK WITH HARDWARE - 360 MM BACK HEIGHT - CURVED 80 MM - MINI FASTENERS	NC : 0471, 0474, 0475, 0477, 0478, 0479, 0480, 0481, 0657, 0677, 0757, 0777, 0882, 0940, 0945	717,54
CEP0461	<input type="checkbox"/>	MATRX ELITE E2 BACK WITH HARDWARE - 410 MM BACK HEIGHT - CURVED 80 MM - MINI FASTENERS	NC : 0471, 0474, 0475, 0477, 0478, 0479, 0480, 0481, 0657, 0677, 0757, 0777, 0882, 0940, 0945	717,54
CEP0462	<input type="checkbox"/>	MATRX ELITE E2 BACK WITH HARDWARE - 460 MM BACK HEIGHT - CURVED 80 MM - STANDARD FASTENERS	NC : 0471, 0474, 0475, 0477, 0478, 0479, 0480, 0481, 0657, 0677, 0757, 0777, 0882, 0940, 0945	717,54
CEP0457	<input type="checkbox"/>	MATRX ELITE E2 BACK WITH HARDWARE - 510 MM BACK HEIGHT - CURVED 80 MM - STANDARD FASTENERS	NC : 0471, 0474, 0475, 0477, 0478, 0479, 0480, 0481, 0657, 0677, 0757, 0777, 0882, 0940, 0945	717,54
CEP0458	<input type="checkbox"/>	MATRX ELITE DEEP E2 BACK WITH HARDWARE - 160 MM BACK HEIGHT - CURVED 160 MM - MINI FASTENERS	NC : 0471, 0474, 0475, 0477, 0478, 0479, 0480, 0481, 0657, 0677, 0757, 0777, 0882, 0940, 0945	717,54
CEP0459	<input type="checkbox"/>	MATRX ELITE DEEP E2 BACK WITH HARDWARE - 210 MM BACK HEIGHT - CURVED 160 MM - MINI FASTENERS	NC : 0471, 0474, 0475, 0477, 0478, 0479, 0480, 0481, 0657, 0677, 0757, 0777, 0882, 0940, 0945	717,54
CEP0466	<input type="checkbox"/>	MATRX ELITE DEEP E2 BACK WITH HARDWARE - 260 MM BACK HEIGHT - CURVED 160 MM - MINI FASTENERS	NC : 0471, 0474, 0475, 0477, 0478, 0479, 0480, 0481, 0657, 0677, 0757, 0777, 0882, 0940, 0945	717,54
CEP0467	<input type="checkbox"/>	MATRX ELITE DEEP E2 BACK WITH HARDWARE - 310 MM BACK HEIGHT - CURVED 160 MM - MINI FASTENERS	NC : 0471, 0474, 0475, 0477, 0478, 0479, 0480, 0481, 0657, 0677, 0757, 0777, 0882, 0940, 0945	717,54
CEP0468	<input type="checkbox"/>	MATRX ELITE DEEP E2 BACK WITH HARDWARE - 360 MM BACK HEIGHT - CURVED 160 MM - MINI FASTENERS	NC : 0471, 0474, 0475, 0477, 0478, 0479, 0480, 0481, 0657, 0677, 0757, 0777, 0882, 0940, 0945	717,54
CEP0463	<input type="checkbox"/>	MATRX ELITE DEEP E2 BACK WITH HARDWARE - 410 MM BACK HEIGHT - CURVED 160 MM - MINI FASTENERS	NC : 0471, 0474, 0475, 0477, 0478, 0479, 0480, 0481, 0657, 0677, 0757, 0777, 0882, 0940, 0945	717,54
CEP0464	<input type="checkbox"/>	MATRX ELITE DEEP E2 BACK WITH HARDWARE - 460 MM BACK HEIGHT - CURVED 160 MM - STANDARD FASTENERS	NC : 0471, 0474, 0475, 0477, 0478, 0479, 0480, 0481, 0657, 0677, 0757, 0777, 0882, 0940, 0945	717,54
CEP0469	<input type="checkbox"/>	MATRX ELITE DEEP E2 BACK WITH HARDWARE - 510 MM BACK HEIGHT - CURVED 160 MM - STANDARD FASTENERS	NC : 0471, 0474, 0475, 0477, 0478, 0479, 0480, 0481, 0657, 0677, 0757, 0777, 0882, 0940, 0945	717,54



Matrx Elite E2 / Elite Deep E2



Standard



Split

Please note - loss of approximately 20 mm in seat depth with reclining backrests using jacks - delivered with Mini or Standard fixings except for the PMH backrests delivered with the Split fixing.

Matrx backrest width - see chart at end of order form

CEP0482	<input type="checkbox"/>	360 MM - INDICATIVE BUST WIDTH : 265 MM		<input type="radio"/>
CEP0483	<input type="checkbox"/>	380 MM - INDICATIVE BUST WIDTH : 290 MM		<input type="radio"/>
CEP0484	<input type="checkbox"/>	410 MM - INDICATIVE BUST WIDTH : 315 MM		<input type="radio"/>
CEP0485	<input type="checkbox"/>	430 MM - INDICATIVE BUST WIDTH : 340 MM		<input type="radio"/>
CEP0486	<input type="checkbox"/>	460 MM - INDICATIVE BUST WIDTH : 370 MM		<input type="radio"/>
CEP0487	<input type="checkbox"/>	480 MM - INDICATIVE BUST WIDTH : 390 MM		<input type="radio"/>
CEP0488	<input type="checkbox"/>	510 MM - INDICATIVE BUST WIDTH : 420 MM		<input type="radio"/>

BACKREST UPHOLSTERY TYPE				
CEP0471	<input type="checkbox"/>	STANDARD NYLON SLING TYPE (JEMIMA)	NC : 0882, 0905, 0906, 0907	○
CEP0474	<input type="checkbox"/>	LUMBAR SUPPORT (+1 STRAP) BI MATERIAL PADDED COVER INCL. BACK POCKET		33,08
CEP0475	<input type="checkbox"/>	LUMBAR SUPPORT (+1 STRAP) PADDED SHAPED COVER		◆
CEP0477	<input type="checkbox"/>	CONTOUR ADJUSTABLE (3+1 STRAPS) BI MATERIAL PADDED COVER INCL. BACK POCKET		○
CEP0478	<input type="checkbox"/>	CONTOUR ADJUSTABLE (3+1 STRAPS) BI MATERIAL PADDED COVER INCL. BACK POCKET	NC : 0940, 0945	66,16
CEP0479	<input type="checkbox"/>	CONTOUR ADJUSTABLE (3+1 STRAPS) PADDED SHAPED COVER	NC : 0940, 0945	33,08
CEP0480	<input type="checkbox"/>	CONTOUR ADJUSTABLE (7+1 STRAPS) PADDED SHAPED COVER	NC : 0940, 0945	138,39
CEP0481	<input type="checkbox"/>	CONTOUR ADJUSTABLE (7+1 STRAPS) BI MATERIAL PADDED COVER INCL. BACK POCKET	NC : 0940, 0945	189,57

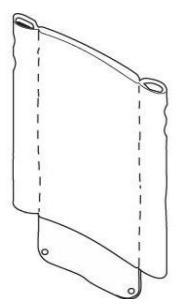

0471

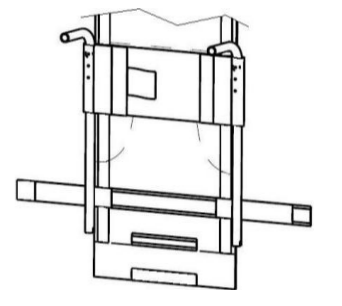

0474 / 0475

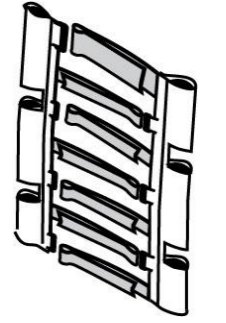

0480 / 0481

HANGERS/FOOTPLATES

HANGERS RH TYPE

CEP0510	<input type="checkbox"/>	80° STRAIGHT RH SWING IN/SWING OUT HANGER		◆
CEP0520	<input type="checkbox"/>	ELEVATING LEGREST (0° TO 75°) RH SWING IN/SWING OUT HANGER (INCLUDING CALFPAD)	NC : 0611, 0930, 0935, 0936	73,82
CEP0545	<input type="checkbox"/>	AMPUTEE LEGREST RH	NC : 0600, 0610, 0611, 0930, 0936	140,28



0510 / 0560

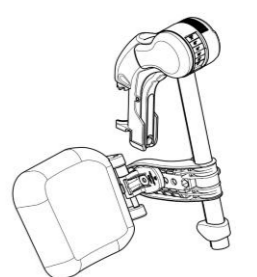

0520 / 0570

HANGERS LH TYPE

CEP0560	<input type="checkbox"/>	80° STRAIGHT LH SWING IN/SWING OUT HANGER		◆
CEP0570	<input type="checkbox"/>	ELEVATING LEGREST (0° TO 75°) LH SWING IN/SWING OUT HANGER (INCLUDING CALFPAD)	NC: 0611, 0930, 0935, 0936	73,82
CEP0595	<input type="checkbox"/>	AMPUTEE LEGREST LH	NC : 0611, 0620, 0630, 0930, 0936	140,28



0545 / 0595

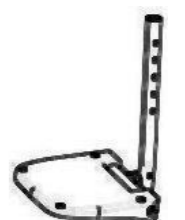

0610 / 0630

FOOTPLATES RH TYPE

CEP0600	<input type="checkbox"/>	FLIP UP RH FOOTPLATE		◆
CEP0610	<input type="checkbox"/>	FLIP UP DEPTH & ANGLE AJUSTABLE RH FOOTPLATE		26,43
CEP0611	<input type="checkbox"/>	FLIP UP ONE PIECE FOOTPLATE	NC : 0620, 0630, 0935, 0936	234,12

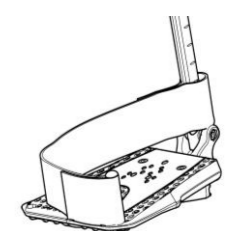

0610 / 0630

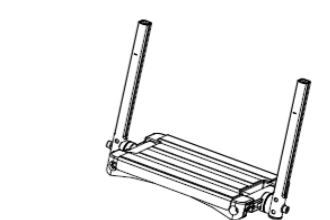

0611

FOOTPLATES LH TYPE

CEP0620	<input type="checkbox"/>	FLIP UP LH FOOTPLATE		◆
CEP0630	<input type="checkbox"/>	FLIP UP DEPTH & ANGLE AJUSTABLE LH FOOTPLATE		26,43

ARMRESTS











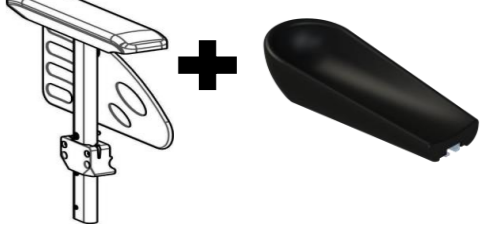



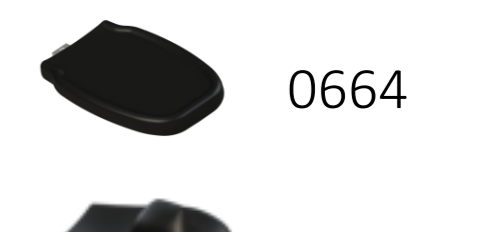

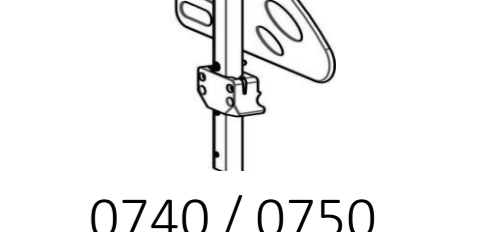

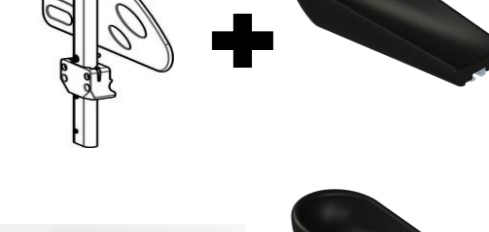

A SINGLE CONCAVE HEMI WITH A CHOICE OF FLAT, CURVED OR CURVED HORN PALM SUPPORT AT NO ADDITIONAL PRICE.

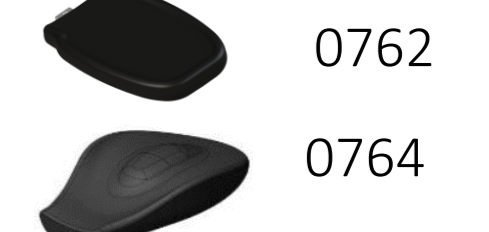
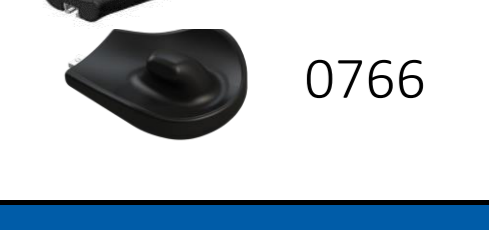
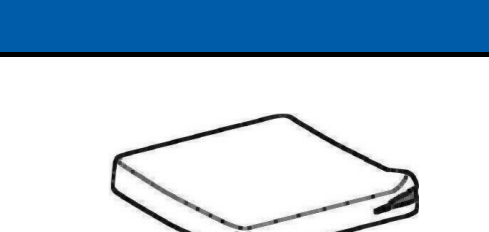





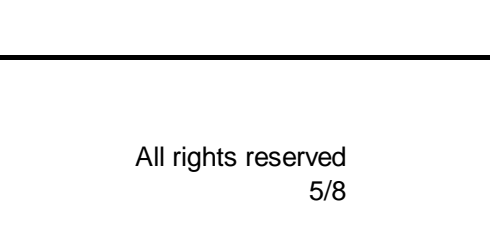





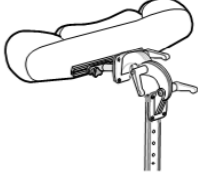







HEMI concave armrest adjustable in depth over 100 mm including right or left reversible rotator 360° in 18° steps.

Choice of: flat and ambidextrous palm support OR curved and ambidextrous palm support OR right or left curved horn palm support

All the dimensions of these different elements available at the end of the order form. Warning: if the backrest is set at an angle and can be folded down on the selected seat, it is mandatory to remove the omission with the concave armrest to fold down the backrest

ARMRESTS RH FORM IN BLACK COLOR					
CEP0640	<input type="checkbox"/>	REMOVABLE RH (N°1) AUTOLOCK SAFETY DEVICE INCLUDED - DESK - ADJ. 200 TO 280 MM HEIGHT	NC : 0662, 0664, 0666, 0780, 0790	◆	
CEP0650	<input type="checkbox"/>	REMOVABLE RH (N°1) AUTOLOCK SAFETY DEVICE INCLUDED - FULL LENGTH - ADJ. 200 TO 280 MM HEIGHT	NC : 0662, 0664, 0666, 0780, 0790	○	
CEP0657	<input type="checkbox"/>	REMOVABLE RH (N°1) AUTOLOCK SAFETY DEVICE INCLUDED - ROTATIVE HEMI ARMPAD WITH PALMAR SUPPORT (360°) - ADJ. 200 TO 280 MM HEIGHT & DEPTH	NC : 0757, 0777	○	
CEP0677	<input type="checkbox"/>	SWING AWAY DETACHABLE RH (N°3) - ROTATIVE HEMI ARMPAD WITH PALMAR SUPPORT (360°) - ADJ. IN HEIGHT (170-295 MM) & DEPTH	NC : 0757, 0777	○	
CEP0680	<input type="checkbox"/>	SWING AWAY DETACHABLE RH (N°3) - DESK - ADJ. IN HEIGHT (170-295 MM)	NC : 0662, 0664, 0666, 0740, 0750	○	
CEP0690	<input type="checkbox"/>	SWING AWAY DETACHABLE RH (N°3) - FULL LENGTH - ADJ. IN HEIGHT (170-295 MM) & DEPTH	NC : 0740, 0750, 0760, 0770	○	
PALMAR SUPPORT RH					
CEP0662	<input type="checkbox"/>	FLAT PALMAR SUPPORT RH		○	
CEP0664	<input type="checkbox"/>	CURVED PALMAR SUPPORT RH		○	
CEP0666	<input type="checkbox"/>	HORN TYPE PALMAR SUPPORT RH		○	
ARMRESTS LH FORM IN BLACK COLOR					
CEP0740	<input type="checkbox"/>	REMOVABLE LH (N°1) AUTOLOCK SAFETY DEVICE INCLUDED - DESK - ADJ. 200 TO 280 MM HEIGHT	NC : 0762, 0764, 0766	○	
CEP0750	<input type="checkbox"/>	REMOVABLE LH (N°1) AUTOLOCK SAFETY DEVICE INCLUDED - FULL LENGTH - ADJ. 200 TO 280 MM HEIGHT	NC : 0762, 0764, 0766	○	
CEP0757	<input type="checkbox"/>	REMOVABLE LH (N°1) AUTOLOCK SAFETY DEVICE INCLUDED - ROTATIVE HEMI ARMPAD WITH PALMAR SUPPORT (360°) - ADJ. 200 TO 280 MM HEIGHT & DEPTH		◆	
CEP0777	<input type="checkbox"/>	SWING AWAY DETACHABLE LH (N°3) - ROTATIVE HEMI ARMPAD WITH PALMAR SUPPORT (360°) - ADJ. IN HEIGHT (170-295 MM) & DEPTH		○	
CEP0780	<input type="checkbox"/>	SWING AWAY DETACHABLE LH (N°3) - DESK - ADJ. IN HEIGHT (170-295 MM)	NC : 0762, 0764, 0766	○	
CEP0790	<input type="checkbox"/>	SWING AWAY DETACHABLE LH (N°3) - FULL LENGTH - ADJ. IN HEIGHT (170-295 MM) & DEPTH	NC : 0762, 0764, 0766	○	
PALMAR SUPPORT LH					
CEP0762	<input type="checkbox"/>	FLAT PALMAR SUPPORT LH		◆	
CEP0764	<input type="checkbox"/>	CURVED PALMAR SUPPORT LH		○	
CEP0766	<input type="checkbox"/>	HORN TYPE PALMAR SUPPORT LH		○	
SEAT CUSHION TYPE					
Cushion					
CEP0849	<input type="checkbox"/>	BASIC 60 MM FOAM CUSHION	NC : 0853, 0854, 0855, 0856, 0871, 0873	33,08	
CEP0853	<input type="checkbox"/>	CLASSIC VISCO CUSHION 375X 400 MM	NC : 0871, 0873, 0878, 0879	76,78	
CEP0854	<input type="checkbox"/>	CLASSIC VISCO CUSHION 405 X 400 MM	NC : 0871, 0873, 0878, 0879	65,40	
CEP0855	<input type="checkbox"/>	CLASSIC VISCO CUSHION 430 X 430 MM	NC : 0871, 0873, 0878, 0879	65,40	
CEP0856	<input type="checkbox"/>	CLASSIC VISCO CUSHION 455 X 400 MM	NC : 0871, 0873, 0878, 0879	76,78	
CEP0871	<input type="checkbox"/>	MATRX CONTOUR NG VISCO CUSHION	NC : 0873	76,78	
CEP0873	<input type="checkbox"/>	MATRX FLO-TECH IMAGE CUSHION		246,45	
CEP0876	<input type="checkbox"/>	MATRX LIBRA CUSHION		293,84	
SEAT CUSHION DEPTH					
CEP0878	<input type="checkbox"/>	FOR 400 MM SEAT DEPTH		○	
CEP0879	<input type="checkbox"/>	FOR 450 MM SEAT DEPTH		○	

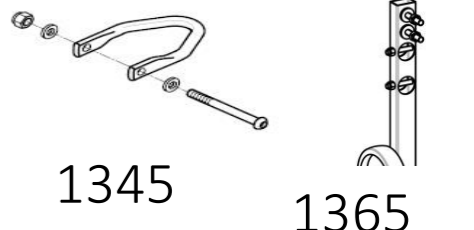
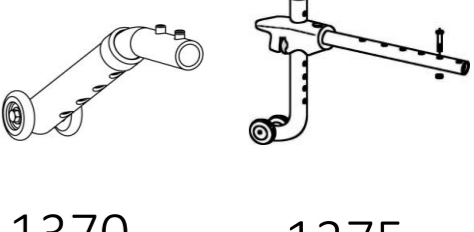
OTHER SEATING OPTIONS					
CEP0852	<input type="checkbox"/>	SEAT RIGIDIZER	(Mandatory: Choose a seat cushion)	○	
CEP0882	<input type="checkbox"/>	LATERAL POSITIONING PADS (PAIR)		237,91	0882
CEP0905	<input type="checkbox"/>	NECKREST BLACK PU TR26 (INCLUDING BACKBRACE EXCEPT FOR LAGUNA)	NC : 0906, 0907, 0940, 0945	60,10	 0905
CEP0906	<input type="checkbox"/>	HEADREST BLACK PU TR26 (INCLUDING BACKBRACE EXCEPT FOR LAGUNA)	NC : 0907, 0940, 0945	199,05	 
CEP0907	<input type="checkbox"/>	HEADREST WITH CHEEK SUPPORT BLACK PU TR26 (INCLUDING BACKBRACE EXCEPT FOR LAGUNA)	NC : 0940, 0945	217,06	0906 0907
CEP0908	<input type="checkbox"/>	MATRX SOFT PAD HEADREST (SOFT PAD 250MM) WITH FIXED HARDWARE		441,71	 0908
CEP0930	<input type="checkbox"/>	ADJUSTABLE CALF STRAP		10,43	
CEP0935	<input type="checkbox"/>	LONGER FOOTREST TUBE (UL= 450-530 MM)	NC : 0936	17,06	
CEP0936	<input type="checkbox"/>	SHORTER FOOTREST SUPPORT (PAIR) (UL= 230-430 MM)		83,41	
CEP0940	<input type="checkbox"/>	BACKBRACE	NC : 0945	47,39	
CEP0945	<input type="checkbox"/>	FOLDABLE BACKBRACE	NC : 1451	105,21	0945
COLOURS					
CEP0961	<input type="checkbox"/>	SLATE GREY (RAL7024 FINE TEXTURE)		○	
CEP0964	<input type="checkbox"/>	PEARL WHITE		○	
CEP0966	<input type="checkbox"/>	MATT BLACK		○	
CEP0967	<input type="checkbox"/>	BLUE POP		○	
CEP0969	<input type="checkbox"/>	RED MATT		○	
CEP0974	<input type="checkbox"/>	NAVY BLUE		○	
CEP0980	<input type="checkbox"/>	ANTHRACITE BLACK		○	0974 / 0969 / 0980
CEP0991	<input type="checkbox"/>	SPECIAL COLOUR		On Demand	
CASTER HOUSING TYPE					
CEP0995	<input type="checkbox"/>	STANDARD		◆	
FRONT WHEELS					
CEP1005	<input type="checkbox"/>	200 X 32 MM (8" X 1.1/4") - BLACK PNEUMATIC TYRE		○	 1050
CEP1010	<input type="checkbox"/>	200 X 30 MM (8" X 1.1/4") - BLACK SOLID TYRE		○	
CEP1030	<input type="checkbox"/>	200 X 45 MM (8" X 2") - BLACK SOLID TYRE		○	
CEP1035	<input type="checkbox"/>	150 X 30 MM (6" X 1.1/4") - BLACK SOLID TYRE MEDIUM HARD		○	
CEP1050	<input type="checkbox"/>	150 X 30 MM (6" X 1.1/4") - BLACK SOLID TYRE		◆	
CEP1054	<input type="checkbox"/>	125 X 30 MM (5" X 1") - BLACK SOLID TYRE		○	
CEP1056	<input type="checkbox"/>	140 X 40 MM (5" 1/2 X 1" 3/4) - BLACK SOLID TYRE MEDIUM HARD		○	
REAR WHEELS					
REAR WHEEL SIZE					
CEP1064	<input type="checkbox"/>	20" / 515 MM	NC : 1071, 1073, 1074, 1075, 1088, 1170, 1260, 1280	○	
CEP1066	<input type="checkbox"/>	22" / 560 MM	NC : 1074, 1260	○	
CEP1068	<input type="checkbox"/>	24" / 600 MM	NC : 1261	◆	
REAR WHEEL TYPE					
CEP1071	<input type="checkbox"/>	STANDARD (BLACK HUB, COLORLESS RIM & ZINC PLATTED SPOKES)	NC : 1280	◆	Standard
CEP1072	<input type="checkbox"/>	REINFORCED (COLORLESS HUB, CLEAR ANODIZED RIM & STAINLESS STEEL SPOKES)	NC : 1280	○	
CEP1073	<input type="checkbox"/>	DRUM BRAKE (20/22/24" : COLORLESS HUB, CLEAR ANODIZED RIM & STAINLESS STEEL SPOKES / 12" : BLACK PLASTIC HUB & RIM)	NC : 1270, 1275, 1320, 1330	○	 Composite
CEP1074	<input type="checkbox"/>	COMPOSITE (BLACK PLASTIC HUB & RIM)	NC : 1088, 1260, 1261, 1280	○	
CEP1075	<input type="checkbox"/>	ONE ARM DRIVE (BLACK HUB & ZINC PLATTED SPOKED WITH ONE ARM DRIVE HANDRIM SYSTEM)	NC : 1084, 1140, 1150, 1170, 1185, 1260, 1261, 1280, 1365	○	

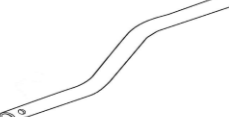
TYRE TYPE						
CEP1082	<input type="checkbox"/>	TYRES SOLID BLACK 35 MM (1"3/8)		◆		
CEP1084	<input type="checkbox"/>	PNEUMATIC PROFILED BLACK 35 MM (1"3/8)		○		1" 1.3/8" 1.3/8"
CEP1088	<input type="checkbox"/>	PNEUMATIC LOW PROFILE BLACK 25 MM (1")		○		1088 1084 1082
HANDRIM TYPE						
CEP1140	<input type="checkbox"/>	ALUMINIUM PRE-ANODIZED HANDRIM		◆		
CEP1150	<input type="checkbox"/>	HANDRIM COATED IN BLACK ANTI-SLIP PLASTIC			127,01	
REAR WHEELS AXLE TYPE						
CEP1170	<input type="checkbox"/>	FIXED AXLE	NC : 1185, 1365	○		
CEP1180	<input type="checkbox"/>	QUICK RELEASE AXLE		◆		
REAR WHEELS POSITION						
CEP1185	<input type="checkbox"/>	ACTIVE REAR WHEELS POSITION - 37,5MM FRONTWARDS/BACKREST CANE AXLE (with Active Rear Wheel Support)	NC : 1320, 1330, 1345, 1365		148,82	
CEP1190	<input type="checkbox"/>	STANDARD REAR WHEELS POSITION - 25MM FRONTWARDS/BACKREST CANE AXLE (12,5MM with Active Rear Wheel Support and Seat Depth 500MM)		◆		
CEP1200	<input type="checkbox"/>	PASSIVE REAR WHEELS POSITION - 25MM BACKWARDS/BACKREST CANE AXLE (12,5MM with Active Rear Wheel Support and Seat Depth 500MM)		○		
CEP1201	<input type="checkbox"/>	DUAL AMPUTEE REAR WHEELS POSITIONS - TRANSIT=75MM BACKWARDS/BACKREST CANE AXLE, ADJUSTABLE TO 50MM BY THE DEALER & SELF PROP=60MM BACKWARDS/BACKREST CANE AXLE, ADJUSTABLE TO 85MM	NC: 1275, 1280, 1320, 1330, 1365		148,82	
PUMP						
CEP1230	<input type="checkbox"/>	PUMP AND SUPPORT			10,43	
CHASSIS OPTIONS TYPE						
CEP1241	<input type="checkbox"/>	FRONT WHEELS EXTENSION (+ 50 MM OUTWARD)		○		 1241
CEP1260	<input type="checkbox"/>	SPOKE GUARDS PAIR 600 MM (24") BLACK	NC : 1261		165,88	
CEP1261	<input type="checkbox"/>	SPOKE GUARDS PAIR CLEAR			165,88	
BRAKES TYPE						
CEP1270	<input type="checkbox"/>	PUSH TO LOCK BRAKES		◆		 1270
CEP1275	<input type="checkbox"/>	PULL TO LOCK BRAKES		○		
CEP1280	<input type="checkbox"/>	ATTENDANT HUB BRAKES (INCLUDING PUSH TO LOCK BRAKES)			178,20	
CEP1320	<input type="checkbox"/>	OAD WIRE CONTROLLED BRAKE RH	NC : 1390		94,79	
CEP1330	<input type="checkbox"/>	OAD WIRE CONTROLLED BRAKE LH	NC : 1390		94,79	
SAFETY OPTIONS TYPE						
CEP1345	<input type="checkbox"/>	TRANSPORTATION BRACKETS		○		 1345 1365
CEP1360	<input type="checkbox"/>	POSTURE BELT - PLASTIC BUCKLE	NC : 1361, 1362, 1363, 1364		31,28	
CEP1361	<input type="checkbox"/>	HIP BELT, 2-PT, CTR-PULL, PB - M X 460MM PADS, FLAT-MOUNT	NC : 1362, 1363, 1364		199,05	 1370 1375
CEP1362	<input type="checkbox"/>	HIP BELT, 2-PT, CTR-PULL, PB - L X 620MM PADS, FLAT-MOUNT	NC : 1363, 1364		206,64	
CEP1363	<input type="checkbox"/>	HIP BELT, 4-PT, CTR-PULL, PB - M X 460MM PADS, FLAT-MOUNT	NC : 1364		234,12	 1361 / 1362
CEP1364	<input type="checkbox"/>	HIP BELT, 4-PT, CTR-PULL, PB - L X 620MM PADS, FLAT-MOUNT			241,71	
CEP1365	<input type="checkbox"/>	TRANSFER KIT (100 MM (4") WHEELS) - ANTI-BARRIER			68,25	 1363 / 1364
CEP1370	<input type="checkbox"/>	REAR ANTI-TIPPERS PAIR -	NC : 1375, 1440		79,62	
CEP1375	<input type="checkbox"/>	REAR ANTI-TIPPERS PAIR WITH TIPPING AID - (REA TYPE)	NC : 1440		125,12	
CEP1380	<input type="checkbox"/>	REFLECTORS KIT			38,86	
CEP1390	<input type="checkbox"/>	BRAKE EXTENSION PAIR			10,43	
ATTENDANT OPTIONS TYPE						
CEP1430	<input type="checkbox"/>	CANE HOLDER			49,29	 1440
CEP1440	<input type="checkbox"/>	TIPPING AID RH			28,44	
CEP1451	<input type="checkbox"/>	DRIP STAND SUPPORT WITH DRIPSTAND (WITH BACKBRACE 0940 ONLY)			101,42	

COMPOSITION AND DIMENSIONS OF THE CONCAVE HEMI ARMREST OFFERED AS A MOUNTED OPTION

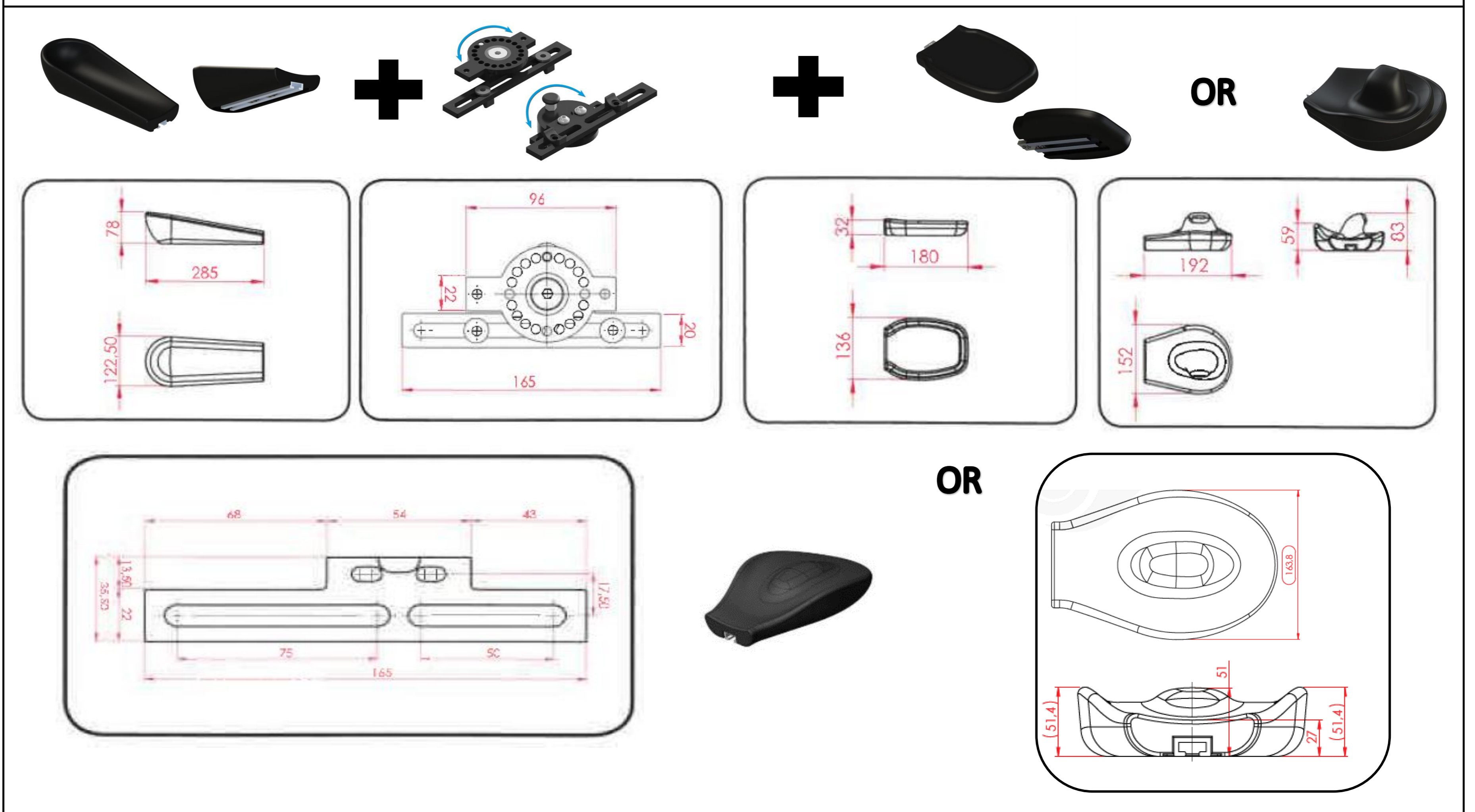

Possible widths of the Matrix backrests depending on the seat width

Backrest Width	Seat Width (mm)						
	(mm)	380	405	430	455	480	505
360	○						
380	○	○					
410	○	○	○				
430		○	○	○			
460			○	○	○		
480				○	○	○	
510					○	○	○

RAMPS					
1440530	<input type="checkbox"/>	Folding mono ramp, fiberglass Folded dimensions: 2000 x 820 mm 16,3 kg - max. load : 300 kg		1 787,68	 1440530
1654128	<input type="checkbox"/>	2-part telescopic Basic Ramp, aluminum and anti-slipping material. Folded dimensions: 1210 x 194 mm. 8,8 kg (pair) - max. load : 270 kg		402,84	 1654128
1654129	<input type="checkbox"/>	3-part telescopic compact Quick2go Ramp, aluminum and anti-slipping material Folded dimensions: 870 x 237 mm 13,6 kg (pair) - max. load: 260 kg		805,69	 1654129
1654130	<input type="checkbox"/>	Folding mono ramp, aluminum Folded dimensions: 1824 x 714 mm 13,9 kg - max. load: 300 kg		426,54	 1654130