

Rea® Azalea® Tall

Please contact Invacare EU Export Customer Services on :-
Tel : +33 247 626980 ; Email : serviceclient_export@invacare.com
Or visit our website : www.invacare.eu.com



Yes, you can.®

Rea® Azalea® Tall

Manual folding frame steel chair - for tall users



CE

Date :

Purchase Order :

Customer Code :

Distributor Stamp :



Description:

- Seat tilt with maintenance of the center of gravity and the correct position of the legrests: +1°/+24° and of the backrest: 0°/30° by pneumatic jacks.
- Width-adjustable legrests.
- Heel straps.
- Frame colour: Pearl gray (RAL 0515).
- Weight: from 34 kg.
- Maximum user weight: 135 kg.
- 2-year warranty period excluding wear parts



Invacare Unique Customization Service
Please specify the quote or special production number:

- Please make your selection with a cross in the box Standard feature Free of charge option

CODE	DESCRIPTION	NC : Non Compatible NC : 9999 = not compatible with the reference 9999	Euros
BNH0019	<input type="checkbox"/> Rea® Azalea® Tall		1 852,13
PROPULSION TYPE			
BNH0025	<input type="checkbox"/> SELF PROPELLED: 24" / 22" WHEELS WITH USER BRAKES	NC : 1076	◆
BNH0030	<input type="checkbox"/> SELF- AND ASSISTANT PROPELLED: 24" / 22" WHEELS WITH HUB BRAKES	NC : 1072, 1074	213,27
SEAT			
SEAT DIMENSIONS			
BNH0040	<input type="checkbox"/> 390 mm - Adjustable from 390 to 440 mm	NC : 0244, 0245, 0246, 0247	○
BNH0050	<input type="checkbox"/> 440 mm - Adjustable from 440 to 490 mm	NC : 0241, 0242, 0246, 0247	○
BNH0060	<input type="checkbox"/> 490 mm - Adjustable from 490 to 540 mm	NC : 0206, 0241, 0242, 0243, 0244	○
Seat width pre-adjustable			
BNH0065	<input type="checkbox"/> Supplied with adjustment + 50 mm (at 440, 490 or 540 mm)		○
Seat depth (SD)			
BNH0105	<input type="checkbox"/> Adjustable from 480 to 550 mm		◆
Floor/seat height (measured without cushion)			
BNH0125	<input type="checkbox"/> 500 mm		◆
SEAT ANGLE			
BNH0127	<input type="checkbox"/> NEGATIVE SEAT ANGLE -1 TO +23° (STD +1 TO +24°)		○
SEAT TYPE			
BNH0130	<input type="checkbox"/> DEPTH ADJUSTABLE		◆
SEAT CUSHION			
BNH0165	<input type="checkbox"/> CUSHION FLOSHAPE		◆
BNH0175	<input type="checkbox"/> CUSHION MISTRAL 2-LAYER	NC : 0191, 0201, 0202	○
SEAT UPHOLSTERY			
BNH0191	<input type="checkbox"/> BLACK PLUSH TR35		79,62
BNH0201	<input type="checkbox"/> BLACK PU TR26 - MUTLI STRETCH PU COATED FABRIC		◆
BNH0202	<input type="checkbox"/> BLACK SPACER TR36		○
BACKREST			
BACKREST WIDTH EXTENSION (PRE ADJUSTMENT)			
BNH0205	<input type="checkbox"/> + 50 MM		○
BNH0206	<input type="checkbox"/> + 100 MM	NC : 0220	○
BNH0207	<input type="checkbox"/> WITHOUT BACKREST WIDTH EXTENSION		◆

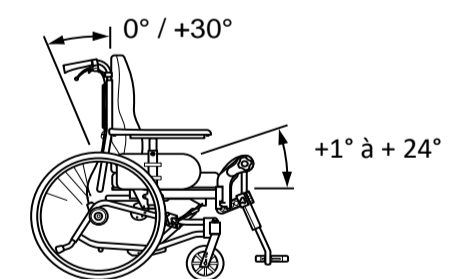
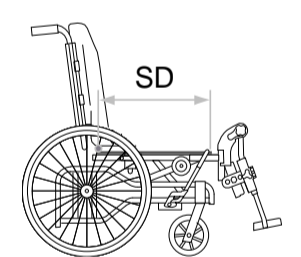
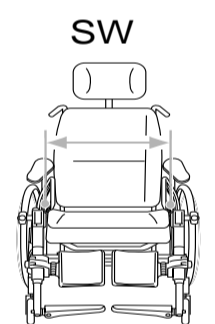

0165

BACKREST TYPE				
BNH0210	<input type="checkbox"/>	FLEX 3 BACKREST, FIXED PLATE (WIDTH ADJUSTABLE)	NC : 0235, 0240, 0241 to 0247, 0341, 0343, 0905	○
BNH0215	<input type="checkbox"/>	BACKREST, PLATE "LAGUNA 2"	NC : 0235, 0240, 0241 to 0247, 0260, 0270, 0335, 0343, 0905	◆
BNH0220	<input type="checkbox"/>	FLEX 3 BACKREST, TENSION ADJUSTABLE (WIDTH ADJUSTABLE)	NC : 0235, 0241 to 0247, 0341, 0343	○
BNH0221	<input type="checkbox"/>	MATRX ELITE E2, (INCL. HARDWARE MOUNTED TO FRAME, BACKREST SUPPLIED IN BOX)	NC : 0240, 0250, 0260, 0270, 0311, 0321,0322, 0335, 0341, 0800, 0810, 0880, 0890, 0905, 0920	717,98
BNH0223	<input type="checkbox"/>	MATRX ELITE DEEP E2, (INCL. HARDWARE MOUNTED TO FRAME, BACKREST SUPPLIED IN BOX)	NC : 0240, 0250, 0260, 0270, 0311, 0321, 0322, 0335, 0341, 0800, 0810, 0880, 0890, 0905, 0920	717,98
BNH0225	<input type="checkbox"/>	MATRX POSTURE BACK, (INCL. HARDWARE MOUNTED TO FRAME, BACKREST SUPPLIED IN BOX)	NC : 0235, 0240, 0241 à 0247, 0250, 0260, 0270, 0311, 0321, 0322, 0335, 0341, 0800, 0810, 0880, 0890, 0905, 0920	717,98
BACKREST HEIGHT MATRX BACKRESTS				
BNH0233	<input type="checkbox"/>	MATRX HEIGHT 41 CM		○
BNH0235	<input type="checkbox"/>	MATRX HEIGHT 46 CM		
BNH0234	<input type="checkbox"/>	MATRX HEIGHT 51 CM		○
Matrx backrest width				
BNH0241	<input type="checkbox"/>	360 mm - indicative bust 265 mm		○
BNH0242	<input type="checkbox"/>	380 mm - indicative bust 290 mm		○
BNH0243	<input type="checkbox"/>	410 mm - indicative bust 315 mm		○
BNH0244	<input type="checkbox"/>	430 mm - indicative bust 340 mm		○
BNH0245	<input type="checkbox"/>	460 mm - indicative bust 370 mm		○
BNH0246	<input type="checkbox"/>	480 mm - indicative bust 390 mm		○
BNH0247	<input type="checkbox"/>	510 mm - indicative bust 420 mm		○
BACKREST COVER/ CUSHION				
BNH0240	<input type="checkbox"/>	COVER, LATERAL		○
BNH0250	<input type="checkbox"/>	CUSHION, LAGUNA (LATERAL SUPPORT)	NC : 0905	◆
BNH0260	<input type="checkbox"/>	CUSHION, MISTRAL 2 (WAIST SUPPORT)	NC : 0322, 0905	146,92
BNH0270	<input type="checkbox"/>	CUSHION, PASSAD 2 (SHOULDER SUPPORT)	NC : 0905	217,06
BACKREST UPHOLSTERY				
BNH0311	<input type="checkbox"/>	BLACK PLUSH TR35		79,62
BNH0321	<input type="checkbox"/>	BLACK PU TR26		◆
BNH0322	<input type="checkbox"/>	BLACK SPACER TR36		○
PUSHHANDLES				
BNH0335	<input type="checkbox"/>	HEIGHT ADJUSTABLE AND REMOVABLE PUSHHANDLES		◆
BNH0341				
BNH0343				
BNH0345	<input type="checkbox"/>	ANGLE ADJUSTABLE PUSHBAR	NC : 1266	145,97
SEAT TILT AND BACKREST REGULATION TYPE				
BNH0350	<input type="checkbox"/>	ASSISTANT OPERATED GAS PISTON SEAT AND BACKREST TILT.		◆
BNH0360	<input type="checkbox"/>	ELECTRIC BY REMOTE CONTROL - COMPLIES WITH EN 12184 : 2014	NC : 1263, 1266	995,26
BNH1263	<input type="checkbox"/>	TILT LOCK (LOCKING OF PRE-SET ANGLE)		◆
LEGRESTS / FOOTRESTS				
CENTRAL LEGRESTS TYPE				
BNH0370	<input type="checkbox"/>	CENTRAL LEGREST, INCL CALFPAD AND FOOTREST.	NC : 0376, 0378, 0380, 0390, 0410, 0430, 0440, 0460, 0476, 0520, 0580, 0720, 0941, 0942, 0952, 0954, 0956	900,47
LEGRESTS / HANGERS ADJUSTMENT				
BNH0375	<input type="checkbox"/>	LOW POSITION, STANDARD		◆
BNH0376	<input type="checkbox"/>	HIGH POSITION FOR LONGER LEGS		109,00
BNH0378	<input type="checkbox"/>	90° HANGER ATTACHMENT	NC : 0390, 0410, 0440, 0460	52,13



0210



0215

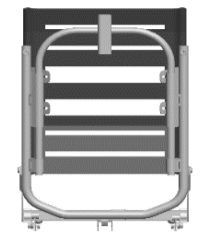

0220

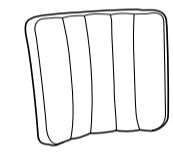
Matrx Elite E2 /
Elite Deep E2

0240

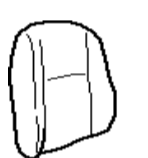

0250



0260

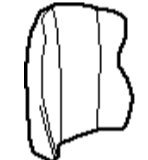

0270



0345

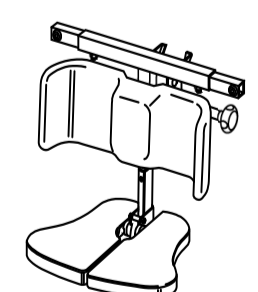

0370

LEGRESTS / HANGERS LH TYPE				
BNH0380	<input type="checkbox"/>	HANGER ANGLE ADJUSTABLE LH. WITH KNEE PAD AND CALF SUPPORT	NC : 0475, 0490, 0942	◆
BNH0390	<input type="checkbox"/>	HANGER FIXED 80 DEG, SWING IN SWING OUT - ALU 2003, LH		○
BNH0410	<input type="checkbox"/>	LEGREST AMPUTEE - ALU 2008 LH	NC : 0475, 0476, 0490, 0520, 0941, 0942	140,28
LEGRESTS / HANGERS RH TYPE				
BNH0430	<input type="checkbox"/>	HANGER ANGLE ADJUSTABLE RH. WITH KNEE PAD AND CALF SUPPORT	NC : 0475, 0550, 0942	◆
BNH0440	<input type="checkbox"/>	HANGER FIXED 80 DEG, SWING IN SWING OUT - ALU 2003, RH		○
BNH0460	<input type="checkbox"/>	LEGREST AMPUTEE - ALU 2008 RH	NC : 0475, 0476, 0550, 0580, 0941, 0942	140,28
FOOTRESTS				
FOOTRESTS ONE PIECE				
BNH0475	<input type="checkbox"/>	FOOTREST ONE PIECE DEPTH AND ANGLE ADJUSTABLE, NO WIDTH ADJUSTMENT - SHORT TUBE	NC : 0490, 0520, 0550, 0580, 0930, 0940, 0952, 0954, 0956	202,84
BNH0476	<input type="checkbox"/>	FOOTREST ONE PIECE DEPTH AND ANGLE ADJUSTABLE, NO WIDTH ADJUSTMENT - LONG TUBE	NC : 0520, 0580, 0952, 0954, 0956	249,29
FOOTRESTS LH TYPE				
BNH0490	<input type="checkbox"/>	FOOTREST LOWER PART, DEPTH AND ANGLE ADJUSTABLE WITH SHORT TUBE AND HEEL STRAP, LH		○
BNH0520	<input type="checkbox"/>	FOOTREST LOWER PART, DEPTH AND ANGLE ADJUSTABLE WITH LONG TUBE AND HEEL STRAP, LH		◆
FOOTRESTS RH TYPE				
BNH0550	<input type="checkbox"/>	FOOTREST LOWER PART, DEPTH AND ANGLE ADJUSTABLE WITH SHORT TUBE AND HEEL STRAP, RH		○
BNH0580	<input type="checkbox"/>	FOOTREST LOWER PART, DEPTH AND ANGLE ADJUSTABLE WITH LONG TUBE AND HEEL STRAP, RH		◆
ARMRESTS (Height adjustable, Autolock attachment included)				
ARMRESTS LH TYPE				
BNH0600	<input type="checkbox"/>	STANDARD PAD, LH	NC : 1232	○
BNH0606	<input type="checkbox"/>	CONCAVE GUTTER ADJUSTABLE IN HEIGHT AND DEPTH 70 MM WITHOUT TOOLS (COMPATIBLE WITH SHELF)	NC : 1232	◆
BNH0610	<input type="checkbox"/>	PADDED, LH.	NC : 0680, 0690, 1230, 1231, 1233, 1250	○
BNH0615	<input type="checkbox"/>	HEMIPLEGIC ARMRESTS, LH.	NC : 1230, 1231, 1233, 1240, 1245, 1250	○
BNH0620	<input type="checkbox"/>	WITHOUT ARMREST, LH	NC : 0690, 1230, 1231, 1240, 1245, 1250	○
ARMRESTS RH TYPE				
BNH0630	<input type="checkbox"/>	STANDARD PAD, RH	NC : 1233	○
BNG0636	<input type="checkbox"/>	CONCAVE GUTTER ADJUSTABLE IN HEIGHT AND DEPTH OVE 70 MM WITHOUT TOOLS (COMPATIBLE WITH SHELF)	NC : 1232	◆
BNH0640	<input type="checkbox"/>	PADDED, RH.	NC : 0680, 0690, 1230, 1231, 1232, 1250	○
BNH0645	<input type="checkbox"/>	HEMIPLEGIC ARMRESTS, RH.	NC : 1230, 1231, 1232, 1240, 1245, 1250	○
BNH0650	<input type="checkbox"/>	WITHOUT ARMREST, RH	NC : 0690, 1230, 1231, 1240, 1245, 1250	○
SEATING OPTIONS				
ARMREST OPTIONS				
BNH0680	<input type="checkbox"/>	CUSHION TO SIDE REST COVER		69,19
BNH0690	<input type="checkbox"/>	PAD, SIDE REST		15,17
SEAT OPTIONS				
BNH0710	<input type="checkbox"/>	INCONTINENCE COVER		41,71
BNH0720	<input type="checkbox"/>	ABDUCTION CUSHION		246,45

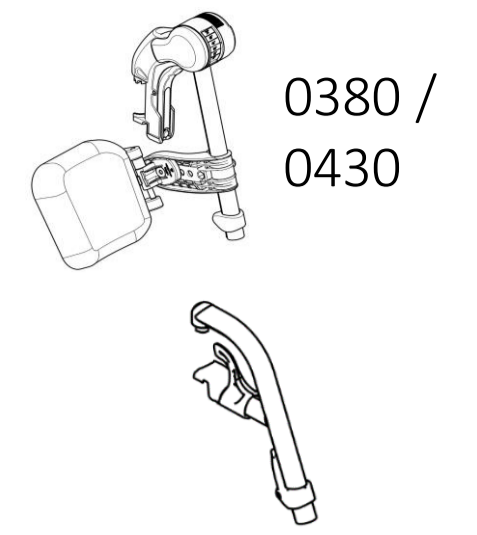

0380 / 0430

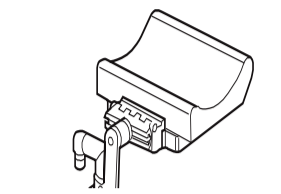

0390 / 0440



0410 / 0460

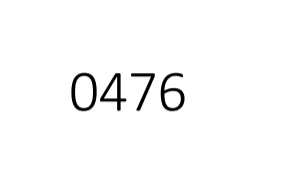

0476



0520 / 0580

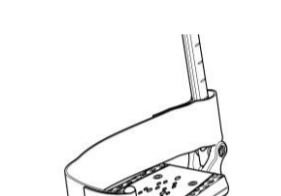

0520 / 0580

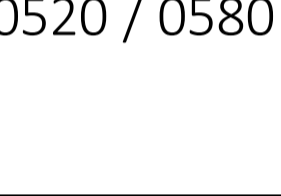

0600 / 0630

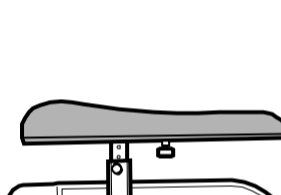

0610 / 0640

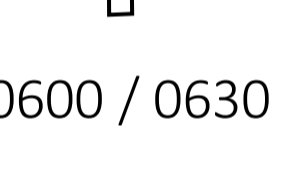

0610 / 0640

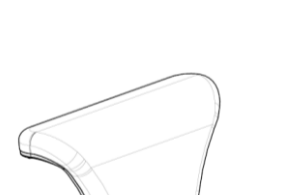

0615 / 0645

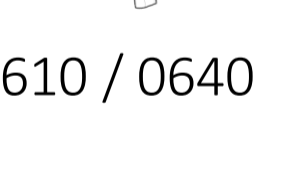









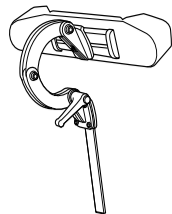
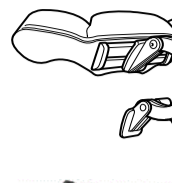

0615 / 0645

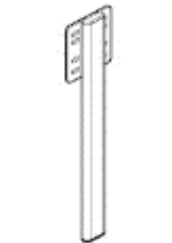
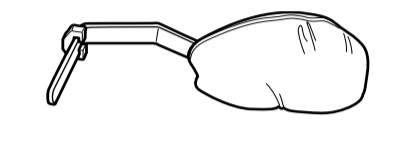
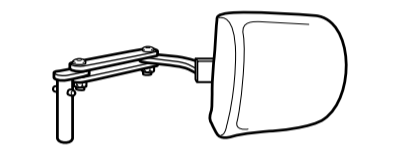

0615 / 0645



0720

BACKREST OPTIONS					
BNH0730	<input type="checkbox"/>	HEADREST, SIDEWISE ADJUSTABLE - FIXED HARDWARE INCLUDED	NC : 0742, 0744, 0746, 0750, 0770	○	 0730
BNH0750	<input type="checkbox"/>	HEADREST WITH CHEEK SUPPORT, SIDEWISE ADJUSTABLE - FIXED HARDWARE INCLUDED	NC : 0740, 0742, 0744, 0746, 0770, 0780	225,59	 0750
BNH0731	<input type="checkbox"/>	MATRIX ELAN STANDARD PAD (254 mm/10")	NC : 0740, 0770	218,01	
BNH0736	<input type="checkbox"/>	MATRIX ELAN 4-POINT PAD (229W x 177H mm / 9"W x 7"H)	NC : 0740, 0770	408,53	
BNH0742	<input type="checkbox"/>	MATRIX ELAN HARDWARE		201,90	
BNH0740	<input type="checkbox"/>	COVER FOR HEADREST		54,03	
BNH0770	<input type="checkbox"/>	NECKREST	NC : 0771	◆	
BNH0782	<input type="checkbox"/>	UNIVERSAL HEAD/NECKREST HOLDER		69,19	
BNH0790	<input type="checkbox"/>	HANDLES CLINIC KIT FOR HEAD-/NECKREST		29,38	
TRUNK SUPPORT LH					
BNH0800	<input type="checkbox"/>	TRUNK SUPPORT MULTI ADJUSTABLE WITH STANDARD ARM (LH)		174,41	 0782
BNH0880	<input type="checkbox"/>	TRUNK SUPPORT SWINGAWAY (LH)		157,35	 0800 / 0810
TRUNK SUPPORT RH					
BNH0810	<input type="checkbox"/>	TRUNK SUPPORT MULTI ADJUSTABLE WITH STANDARD ARM (RH)		174,41	 0880 / 0890
BNH0890	<input type="checkbox"/>	TRUNK SUPPORT SWINGAWAY (RH)		157,35	
BACKREST OPTIONS (Following)					
BNH0905	<input type="checkbox"/>	LATERAL POSITIONING PADS (WITH LOOP BAND BETWEEN COVER AND BACKREST UPHOLSTERY), PAIR		237,91	 0905
BNH0915	<input type="checkbox"/>	TILT SCALE, BACKREST RECLINE		67,30	
BNH0920	<input type="checkbox"/>	WEDGES (ONE PAIR)		16,11	 0952 / 0954 / 0956
LEGREST OPTIONS					
BNH0941	<input type="checkbox"/>	COVER FOOTPLATE		101,42	
BNH0942	<input type="checkbox"/>	CALF STRAP PADDED		119,43	
BNH0952	<input type="checkbox"/>	BODYPOINT ANKLE HUGGERS LARGE	MOUNTING KIT INCLUDED	170,62	
BNH0954	<input type="checkbox"/>	BODYPOINT ANKLE HUGGERS MEDIUM	MOUNTING KIT INCLUDED	170,62	
BNH0956	<input type="checkbox"/>	BODYPOINT ANKLE HUGGERS SMALL	MOUNTING KIT INCLUDED	161,14	
CHASSIS					
CHASSIS COLOUR					
BNH0944	<input type="checkbox"/>	PEARL GREY		◆	 0944
BNH0946	<input type="checkbox"/>	AZURITE		○	 0946
BNH0947	<input type="checkbox"/>	SAND		○	 0947
BNH0948	<input type="checkbox"/>	ELECTRIC GREEN		○	 0948
BNH0949	<input type="checkbox"/>	HAPPY RED		○	 0949
CASTOR ATTACHMENT TYPE					
BNH0960	<input type="checkbox"/>	FIXED		◆	
FRONT CASTORS					
BNH1015	<input type="checkbox"/>	8"x1.1/4" - 200X30 BLACK SOLID TYRE		◆	
BNH1022	<input type="checkbox"/>	8"x1.1/4" - 200X32 PNEUMATIC BLACK		○	
BNH1025	<input type="checkbox"/>	8"x2" - 200X45 BLACK SOLID TYRE		126,07	
REAR WHEELS					
REAR WHEELS SIZE					
BNH1062	<input type="checkbox"/>	24" / 600 MM - QR REAR WHEEL ATTACHMENT		◆	
REAR WHEELS TYPE					
BNH1072	<input type="checkbox"/>	STANDARD (BLACK HUB, COLORLESS RIM & ZINC PLATTED SPOKES)	NC : 1120	◆	
BHN1074	<input type="checkbox"/>	REINFORCED (COLORLESS HUB, CLEAR ANODIZED RIM & STAINLESS STEEL SPOKES)		○	
BHN1076	<input type="checkbox"/>	DRUM BRAKE (22/24" : COLORLESS HUB, CLEAR ANODIZED RIM & STAINLESS STEEL SPOKES / 16" : BLACK PLASTIC HUB & RIM)	NC : 1086	○	
TYRE TYPE					
BNH1082	<input type="checkbox"/>	PNEUMATIC PROFILED BLACK 1" 3/8		○	
BNH1086	<input type="checkbox"/>	PNEUMATIC LOW PROFILE BLACK 1"		○	
BNH1092	<input type="checkbox"/>	TYRES SOLID BLACK 1" 3/8		◆	
HANDRIM TYPE					
BNH1100	<input type="checkbox"/>	ALUMINIUM		◆	
BNH1120	<input type="checkbox"/>	PLASTIC COATED		200,00	

WHEEL OPTIONS					
SPOKEGUARD					
BNH1160	<input type="checkbox"/>	FROST			219,91
SAFETY					
BNH1170	<input type="checkbox"/>	USER MANOUEVERED TYRE BRAKES		◆	
BNH1180	<input type="checkbox"/>	ONE ARM BRAKE LH			327,01
BNH1185	<input type="checkbox"/>	ONE ARM BRAKE RH			327,01
BNH1200	<input type="checkbox"/>	PELVIC BELT - PLASTIC BUCKLE			73,93
BNH1201	<input type="checkbox"/>	BODYPOINT BELT - 2 POINT CENTER-PULL PUSH-BUTTON MEDIUM			120,38
BNH1202	<input type="checkbox"/>	BODYPOINT BELT - 2 POINT CENTER-PULL PUSH-BUTTON LARGE			127,01
BNH1203	<input type="checkbox"/>	BODYPOINT BELT - 4 POINT CENTER-PULL PUSH-BUTTON MEDIUM			134,60
BNH1204	<input type="checkbox"/>	BODYPOINT BELT - 4 POINT CENTER-PULL PUSH-BUTTON LARGE			142,18
BNH1206	<input type="checkbox"/>	BODYPOINT PIVOTFIT HARNESS MEDIUM	ONLY WITH ELITE E2 /ELITE DEEP E2 BACKS OR WITH HEADREST OR NECKREST		220,85
BNH1207	<input type="checkbox"/>	BODYPOINT PIVOTFIT HARNESS LARGE	ONLY WITH ELITE E2 /ELITE DEEP E2 BACKS OR WITH HEADREST OR NECKREST		227,49
OPTIONS					
<i>Think of Bodypoint positioning accessories: belts, harnesses, ankle supports.</i>					
OTHER OPTIONS					
TRAYS					
BNH1230	<input type="checkbox"/>	TABLE TRAY INCL MOUNTING KIT	NC : 1237		72,83
BNH1231	<input type="checkbox"/>	TABLE TRAY INCL MOUNTING KIT, WITH ELBOW PADS	NC : 1237		154,50
BNH1232	<input type="checkbox"/>	HALF TABLE TRAY, CLEAR, FLIP UP, LH (ARMREST WITH STRAIGHT NARROW PAD INCL.)	NC : 1235		72,83
BNH1233	<input type="checkbox"/>	HALF TABLE TRAY, CLEAR, FLIP UP, RH (ARMREST WITH STRAIGHT NARROW PAD INCL.)	NC : 1235		72,83
BNH1240	<input type="checkbox"/>	SWING AWAY TABLE	NC : 1235, 1237, 1250		300,47
BNH1245	<input type="checkbox"/>	SWING AWAY TABLE WITH ELBOW PADS	NC : 1235, 1237, 1250		348,82
TABLE TRAY CUSHION					
BNH1235	<input type="checkbox"/>	TABLE TRAY CUSHION			104,27
BNH1237	<input type="checkbox"/>	PADDING			90,05
OTHER OPTIONS					
BNH1250	<input type="checkbox"/>	LOCKING DEVICE FOR TABLE TRAY			59,72
BNH1266	<input type="checkbox"/>	MOUNTING BRACKET VIAMOBIL			313,74
BNH1300	<input type="checkbox"/>	HARNESS ATTACHMENT			78,67
BNH1310	<input type="checkbox"/>	ATTACHMENT WHEN USING THE PELVIC BELT FOR POSITIONING			28,44
BNH1320	<input type="checkbox"/>	DRIP STAND			105,21
RAMPS					
1440530	<input type="checkbox"/>	Fiberglass Folding Mono Ramp Folded dimensions: 2000 x 230 mm 16.3 kg - maximum capacity: 300 kg			1 787,68
1654128	<input type="checkbox"/>	Basic ramp 2 telescopic parts in aluminum and non-slip coating. Folded dimensions: 1210 x 194 mm. 8.8 kg per pair - maximum capacity: 270 kg			402,84
1654129	<input type="checkbox"/>	Quick2go Compact 3-part aluminum telescopic ramp with non-slip coating Folded dimensions: 870 x 237 mm 13.6 kg per pair - maximum capacity: 260 kg			805,69
1654130	<input type="checkbox"/>	Aluminium folding mono ramp Folded dimensions: 1824 x 714 mm 13.9 kg - maximum capacity: 300 kg			426,54

