

# Rea® Clematis® Pro E-Tilt Configured

Please contact Invacare EU Export Customer Services on :-  
Tel : +33 247 626980 ; Email : serviceclient\_export@invacare.com  
Or visit our website : www.invacare.eu.com



Yes, you can.®

## Rea® Clematis® Pro E-Tilt Configured

Folding frame steel manual comfort chair with electric recliner



### Description:

- Seat and backrest reclining by electric cylinders (from +1° to +30° / -2° to +27° for the seat, from 0° to +30° for the backrest)
- Width adjustment of armrests (+25 mm per side) and legrests (+50 mm per side)
- Seat depth continuously adjustable from 430 to 500 mm via drawer system
- Soft backrest with new Laguna 2 backrest cushion which improves lateral support
- Neck support - Pair of legrests with articulated pallets
- Color Pearly Beige (RAL 1035)
- Maximum user weight: 135 kg.
- Weight: from 35.5 kg
- 2-year warranty period excluding wear parts
- Compatible with Alber engines: e-motion M25, e-fix E35-E36, viamobil V25, viaplus V12
- EU Plug



Date :

Purchase Order :

Customer Code :

Distributor Stamp::

Please make your selection with a cross in the box

◆ Standard feature

○ Free of charge option

CODE	DESCRIPTION	NC : Non Compatible NC : 9999 = not compatible with the reference 9999	Euros	
SNC0002	<input type="checkbox"/> Rea® Clematis® Pro E-Tilt		942,64	
<b>PROPULSION TYPE</b>				
SNC0100	<input type="checkbox"/> SELF PROPULSION (24" REAR WHEELS)	NC : 1500		◆
SNC0110	<input type="checkbox"/> TRANSIT PROPULSION (12" REAR WHEELS)	NC : 0380, 1520		○
<b>FRAME TYPE</b>				
<b>FRAME TYPE</b>				
SNC0210	<input type="checkbox"/> ADJUSTABLE FRAME DEPTH AND WIDTH ADJUSTABLE			◆
<b>SEAT WIDTH</b>				
SNC0300	<input type="checkbox"/> 390mm, adjustable to 440mm			○
SNC0310	<input type="checkbox"/> 440mm, adjustable to 490mm			○
SNC0320	<input type="checkbox"/> 490mm, adjustable to 540mm			○
SNC0330	<input type="checkbox"/> 540mm, adjustable to 590mm	NC : 0430, 1630, 1640	545,02	
<b>SEAT DEPTH</b>				
SNC0370	<input type="checkbox"/> 430 - 500 MM			◆
<b>SEAT HEIGHT</b>				
SNC0380	<input type="checkbox"/> 400 mm	NC : 1430, 1440		○
SNC0390	<input type="checkbox"/> 450 mm			◆
<b>SEAT CUSHIONS</b>				
SNC0410	<input type="checkbox"/> CUSHION MATRX CONTOUR VISCO NG			◆
SNC0420	<input type="checkbox"/> CUSHION MISTRAL 2 BLACK PU TR26		-43,70	
SNC0430	<input type="checkbox"/> CUSHION FLO-SHAPE BLACK PU TR26		-43,70	
<b>BACKREST TYPE</b>				
SNC0500	<input type="checkbox"/> RIGID BACKREST PLATE	NC : 0540, 1000		◆
SNC0510	<input type="checkbox"/> SOFT FABRIC BACKREST	NC : 0540, 1000		○
SNC0520	<input type="checkbox"/> BACKREST LAGUNA 2 TENSION ADJUSTABLE	NC : 0560, 0570, 1200, 1210, 1220, 1230	173,46	
<b>BACKREST CUSHION</b>				
SNC0530	<input type="checkbox"/> CUSHION LAGUNA 2 BLACK PU TR26			◆
SNC0540	<input type="checkbox"/> COVER LATERAL BLACK PU TR26			○
<b>PUSH HANDLES</b>				
SNC0560	<input type="checkbox"/> HEIGHT ADJUSTABLE PUSH HANDLES			◆
SNC0570	<input type="checkbox"/> PUSH BAR ANGLE ADJUSTABLE		145,97	
SNC0580	<input type="checkbox"/> COMBINED PUSH HANDLES			○
<b>SEAT TILT AND BACKREST REGULATION TYPE</b>				
SNC0620	<input type="checkbox"/> ELECTRIC OPERATED BACKREST AND SEAT TILT - EU PLUG			◆

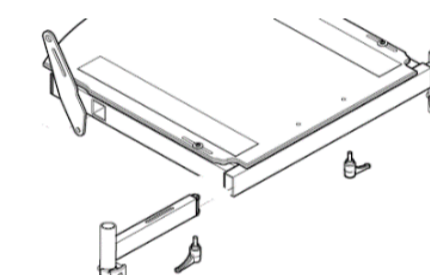

0210



Armrest support



0410

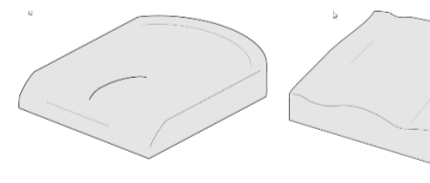

0420 0430



0530



0560

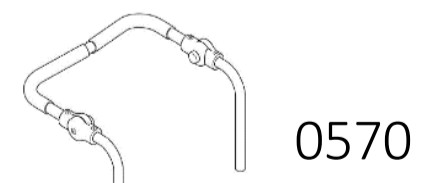

0570

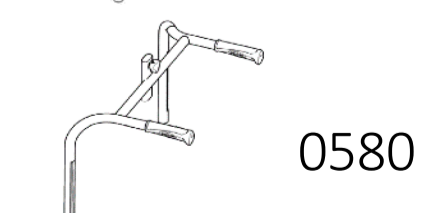

0580

LEGRESTS / FOOTRESTS				
<b>LEGRESTS ADJUSTMENT</b>				
SNC0700	<input type="checkbox"/>	STANDARD LEGREST ATTACHMENT		◆
SNC0710	<input type="checkbox"/>	90° HANGER ATTACHMENT		52,13
<b>LEGRESTS LH TYPE</b>				
SNC0720	<input type="checkbox"/>	LEGREST ANGLE ADJUSTABLE, INCL CALF SUPPORT, LH		◆
<b>LEGRESTS RH TYPE</b>				
SNC0740	<input type="checkbox"/>	LEGREST ANGLE ADJUSTABLE, INCL CALF SUPPORT, RH		◆
<b>FOOTRESTS</b>				
<b>FOOTRESTS LH TYPE</b>				
SNC0770	<input type="checkbox"/>	FOOTREST LOWER PART, DEPTH, WIDTH AND ANGLE ADJUSTABLE WITH HEEL STRAP, LH		◆
<b>FOOTRESTS RH TYPE</b>				
SNC0790	<input type="checkbox"/>	FOOTREST LOWER PART, DEPTH, WIDTH AND ANGLE ADJUSTABLE WITH HEEL STRAP, RH		◆
<b>ARMRESTS (Height adjustable, auto lock attachment included)</b>				
<b>ARMREST LH TYPE</b>				
SNC0800	<input type="checkbox"/>	STANDARD PAD, LH		◆
SNC0810	<input type="checkbox"/>	COMFORT ARMREST PAD, LH	NC : 1720	113,17
SNC0820	<input type="checkbox"/>	HEMIPLEGIC ARMREST ,LH	NC : 1700, 1710, 1720, 1790	113,17
<b>ARMREST RH TYPE</b>				
SNC0850	<input type="checkbox"/>	STANDARD PAD, RH		◆
SNC0860	<input type="checkbox"/>	COMFORT ARMREST PAD, RH	NC : 1730	113,17
SNC0870	<input type="checkbox"/>	HEMIPLEGIC ARMREST,RH	NC : 1700, 1710, 1730, 1790	113,17
<b>SEATING OPTIONS</b>				
<b>SEATING OPTIONS</b>				
SNC0910	<input type="checkbox"/>	ABDUCTION CUSHION		246,45
<b>BACKREST STRAPS</b>				
SNC1000	<input type="checkbox"/>	SUPPORT STRAP FOR BACKREST LAGUNA 2 TENSION ADJUSTABLE		38,86
<b>HEADREST/ NECKREST</b>				
SNC1100	<input type="checkbox"/>	HEADREST ADJUSTABLE WITH HANDWHEEL		209,48
SNC1110	<input type="checkbox"/>	HEADREST WITH CHEEK SUPPORT, SIDEWISE ADJUSTABLE	NC : 1130	225,59
SNC1120	<input type="checkbox"/>	NECKREST FIXED	NC : 1130	◆
SNC1130	<input type="checkbox"/>	COVER FOR HEADREST		57,82
<b>TRUNK SUPPORT</b>				
SNC1200	<input type="checkbox"/>	TRUNK SUPPORT SMALL, LH		174,41
SNC1210	<input type="checkbox"/>	TRUNK SUPPORT SWINGAWAY (LH)		156,40
SNC1220	<input type="checkbox"/>	TRUNK SUPPORT SMALL, RH		174,41
SNC1230	<input type="checkbox"/>	TRUNK SUPPORT SWINGAWAY (RH)		156,40
<b>LEGREST / FOOTREST OPTIONS TYPE</b>				
SNC1300	<input type="checkbox"/>	FOOTPLATE PADDING		103,32
<b>CHASSIS</b>				
<b>CHASSIS COLOURS</b>				
SNC1400	<input type="checkbox"/>	PEARL BEIGE		◆
<b>CASTOR ATTACHMENT TYPE</b>				
SNC1410	<input type="checkbox"/>	CASTOR ATTACHMENT FIXED		◆
<b>FRONT CASTORS</b>				
SNC1420	<input type="checkbox"/>	6"x1.1/4" - 150X30 MM BLACK SOLID TYRE		◆
SNC1430	<input type="checkbox"/>	8"x1.1/4" - 200X30 MM BLACK SOLID TYRE		○
SNC1440	<input type="checkbox"/>	8"x2" - 200X45 MM BLACK SOLID TYRE		○

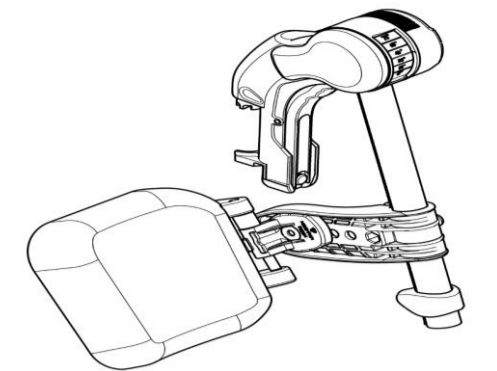

0720 / 0740

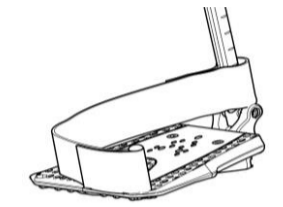

0770

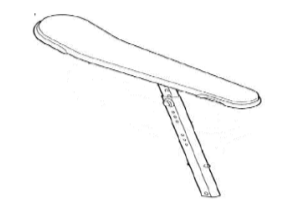

0800



0810

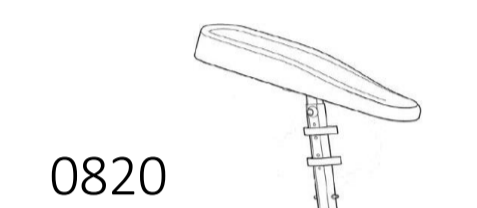

0820

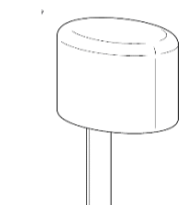

0910

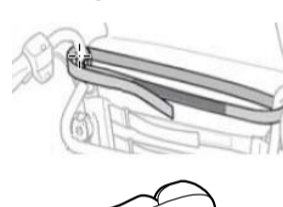

1000

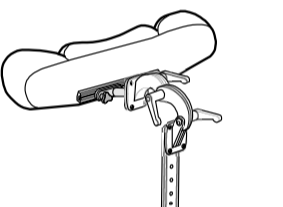

1100

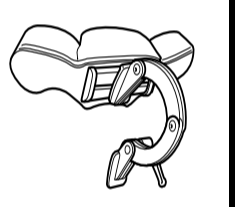

1110

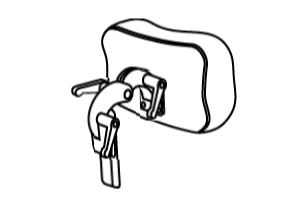

1120

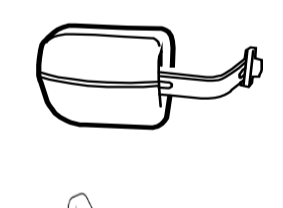

1200

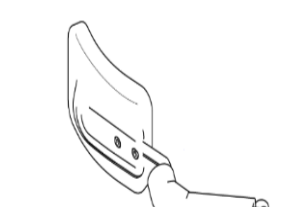

1210

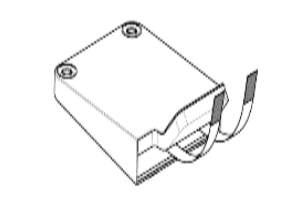

1300



1420



1430

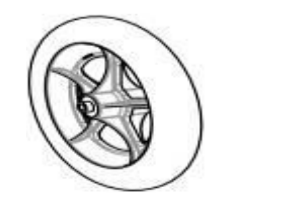

1440

REAR WHEELS SIZE/TYRE				
SNC1500	<input type="checkbox"/>	12" (305 MM) WHEEL	NC : 1530, 1550, 1560, 1600, 1630, 1640	○
SNC1520	<input type="checkbox"/>	24" (610 MM) STANDARD WHEELS	NC : 1620	◆
SNC1525	<input type="checkbox"/>	24" (610 MM) DRUM BRAKE WHEELS	NC : 1620, 1630, 1640	213,27
TYRE TYPE				
SNC1530	<input type="checkbox"/>	BLACK PNEUMATIC PROFILED		○
SNC1540	<input type="checkbox"/>	BLACK TYRES SOLID		◆
HANDRIM TYPE				
SNC1550	<input type="checkbox"/>	HANDRIM ALUMINIUM		◆
SPOKEGUARD				
SNC1560	<input type="checkbox"/>	FROST		219,91
SAFETY				
SNC1600	<input type="checkbox"/>	STANDARD BRAKES		◆
SNC1620	<input type="checkbox"/>	FOOT OPERATED BRAKES	ONLY FOR 12" REAR WHEELS	○
SNC1630	<input type="checkbox"/>	ONE ARM BRAKE LH		327,01
SNC1640	<input type="checkbox"/>	ONE ARM BRAKE RH		327,01
SAFETY OPTIONS				
SNC1650	<input type="checkbox"/>	POSTURE BELT - PLASTIC BUCKLE	Must be checked for Assist version	○
SNC1660	<input type="checkbox"/>	ANTI-TIP DEVICE		◆
ACCESSOIRES				
SNC1700	<input type="checkbox"/>	TABLE TRAY INCL MOUNTING KIT, WITH ELBOW PADS	NC : 1750	154,50
SNC1710	<input type="checkbox"/>	TABLE TRAY INCL MOUNTING KIT	NC : 1750	72,83
SNC1720	<input type="checkbox"/>	HALF TABLE TRAY, CLEAR, FLIP UP, LH WITH STRAIGHT NARROW PAD	NC : 1740	72,83
SNC1730	<input type="checkbox"/>	HALF TABLE TRAY, CLEAR, FLIP UP, RH WITH STRAIGHT NARROW PAD	NC : 1740	72,83
SNC1740	<input type="checkbox"/>	TABLE TRAY CUSHION		101,42
SNC1750	<input type="checkbox"/>	PADDING FOR HALF TABLE TRAY		90,05
SNC1770	<input type="checkbox"/>	MOUNTING BRACKET VIAMOBIL V25		313,74
SNC1780	<input type="checkbox"/>	DRIP STAND		103,32
SNC1790	<input type="checkbox"/>	LOCKING DEVICE FOR TABLE TRAY		59,72
RAMPS				
1440530	<input type="checkbox"/>	<b>Fiberglass Folding Mono Ramp</b> Folded dimensions: 2000 x 230 mm 16.3 kg - maximum capacity: 300 kg"		1 787,68
1654128	<input type="checkbox"/>	<b>Basic ramp 2 telescopic parts in aluminum and non-slip coating</b> - Folded dimensions: 1210 x 194 mm. 8.8 kg per pair - maximum capacity: 270 kg		402,84
1654129	<input type="checkbox"/>	<b>Quick2go Compact 3-part aluminum telescopic ramp with non-slip coating</b> Folded dimensions: 870 x 237 mm 13.6 kg per pair - maximum capacity: 260 kg		805,69
1654130	<input type="checkbox"/>	<b>Aluminium folding mono ramp</b> Folded dimensions: 1824 x 714 mm 13.9 kg - maximum capacity: 300 kg		426,54

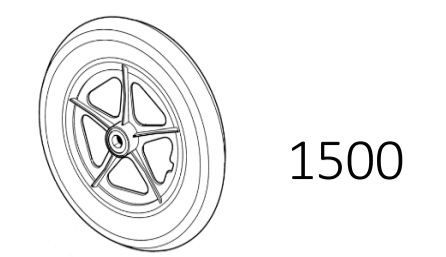

1500



1520

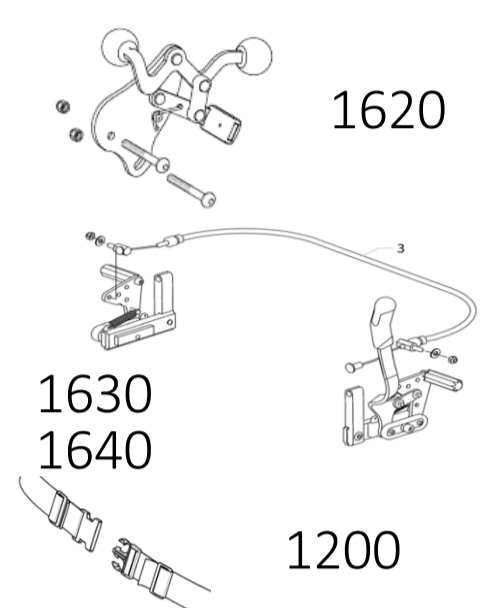

1620

1630  
1640

1200

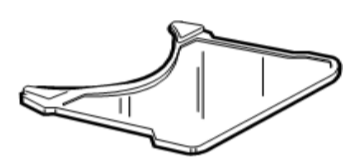

1710



1750



1790



1440530



1654128



1654129

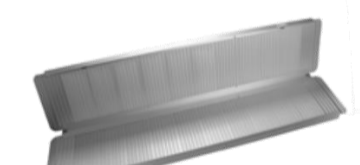

1654130