

Please contact Invacare EU Export Customer Services on :-
Tel : +33 247 626980 ; Email : serviceclient_export@invacare.com
 Or visit our website : www.invacare.eu.com

Assembly by trained service providers or by Invacare



Alber® e-fix®E35

Electric Power Add-On



Description:

- Full engine with two-wheel drive
- Wheels equipped with a bandage insert
- Programmable control box
- 6 Ah Lithium battery and battery charger.
- Wheel diameter 22" or 24".
- Assembly carried out by Invacare or trained service providers
- Maximum user weight: 120kg
- 2-year warranty including batteries and excluding wearing parts.

Date :

Purchase Order :

Customer Code :

Distributor Stamp:

Select the options chosen by a cross in the boxes ◆ Configuration standard ○ Option at no additional cost

CODE	DESCRIPTION	NC: Not Compatible NC: 9999: not compatible with reference 9999	Euros
Installation of the e-fix®E35 kit			
1566180	<input type="checkbox"/> alber e-fix® E35 , 24" or 22" wheels		5 781,99
MANDATORY OPTIONS			
1467178	<input type="checkbox"/> Fixing kit for e-fix wheels		271,09
1584856-EF	<input type="checkbox"/> Installation of the e-fix wheel fixing kit by Invacare (return transport costs not included) <input type="checkbox"/> Average assembly time: 5 working days upon receipt of the chair (In the case of an existing chair, plan to return it to our workshops within 10 days).		323,22
1593206	<input type="checkbox"/> Black anti-tippers with kickstand		355,45
To determine compatibility:			
Armchair from the Invacare® group (Action®, kuschall®), please indicate below the serial number of the wheelchair to be equipped.		Armchair of all other brands, please send us with this sheet the measurement of the wheelchair to be equipped.	
Serial number:			
Warning: Pair of original or Alber anti-tip wheels required.			
The brakes will be adjusted to work with the motorized wheels. For your brakes to be functional with manual wheels, we advise you to equip them with the same coating as the motorized wheels.			
Wheelbase of the chair subject to change. Avoid all options close to the rear bearings which could interfere with assembly.			
Motorized wheel size			
	<input type="checkbox"/> 22"	NC : 1566200, 1566202	○
	<input type="checkbox"/> 24"	NC : 1566201, 1566203	○
ELECTRONIC CONTROLS			
Standard controls			
	<input type="checkbox"/> Joystick right		◆
	<input type="checkbox"/> Joystick left		○
1593361	<input type="checkbox"/> Inward and outward retractable joystick support, multi-adjustable		311,85
	<input type="checkbox"/> joystick on tablet (see tablet with central position)		○
Third-party controls			
1457755	<input type="checkbox"/> Third-party control, movement of the joystick to the left in the backrest		144,08
1457754	<input type="checkbox"/> Third-person control, movement of the joystick to the right in the backrest		144,08



Test the compatibility of the manual wheelchair using the DIP

Intuitive dual control				
1566165	<input type="checkbox"/>	Intuitive double control, 1 handle		677,02
	<input type="checkbox"/>	Additional manual handle for dual control		○
Batteries				
	<input type="checkbox"/>	6 Ah battery (up to 16 km)		◆
1566182	<input type="checkbox"/>	7.5 Ah battery, replaces the standard 6 Ah (up to 22 km)	NC : 1566172	170,62
1565639	<input type="checkbox"/>	Additional 6 Ah battery	NC : 1566174	552,61
1566153	<input type="checkbox"/>	Additional 7.5 Ah battery (only with 7.5 Ah battery)		696,68
OPTIONS				
	<input type="checkbox"/>	Mobility App - the free app on your smartphone! Allows you to connect to your e-fix via Bluetooth to get as much information as possible about your engine (range, instantaneous speed, etc.) Available on App Store and Play Store		
1591926	<input type="checkbox"/>	Pack Mobility Plus- Speed up to 8 km/h (not programmable), visual feedback of incoming calls and text messages*, remote control of the wheelchair Available on Android and iOS (8km/h nc optibox) <i>*Incoming calls and SMS are only available with Android smartphones.</i>		347,87
1566184	<input type="checkbox"/>	Optibox for e-fix E35		293,84
P30094	<input type="checkbox"/>	Red round and flat contactor		110,90
1467698	<input type="checkbox"/>	Sensor for standing chair		262,56
1457743	<input type="checkbox"/>	Support for anti-tipper (only when 1489214 ordered without e-fix®)		146,92
1566200	<input type="checkbox"/>	24" alber decor spoke guards, individually. Desired quantity:	NC : 1566666, 1566201, 1566203	73,93
1566666	<input type="checkbox"/>	24" clear spoke guards per unit. Desired quantity:	NC : 1566201, 1566203	73,93
1566201	<input type="checkbox"/>	22" alber decor spoke guards per unit. Desired quantity:	NC : 1566203	73,93
1566203	<input type="checkbox"/>	22" transparent spoke guards per unit. Desired quantity:		73,93
1566196	<input type="checkbox"/>	Ball for flexible joystick diameter 70 mm	NC : 1565669, 1565670	27,49
1565669	<input type="checkbox"/>	Ball for special joystick diameter 40 mm	NC : 1565670	25,59
1565670	<input type="checkbox"/>	T-control for quadriplegic		95,73
1566197	<input type="checkbox"/>	Extension for gear selector (for limited hand functions)		48,34
1565836	<input type="checkbox"/>	joystick protection		55,92
1566168	<input type="checkbox"/>	Drum bag with Velcro straps		111,85
1566169	<input type="checkbox"/>	Battery bag attachment set	NC : 1566164, 1566163	43,60
1566164	<input type="checkbox"/>	Fastenings on brace for battery (folding armchairs)	NC : 156163	194,31
1566163	<input type="checkbox"/>	Battery axle mounts (non-folding chairs)		160,19
1566177	<input type="checkbox"/>	Remote charging socket (extension plugged into interface)		102,37
1467780	<input type="checkbox"/>	Brake pad extensions		44,55
1566179	<input type="checkbox"/>	Clutch release aid, each		109,95
1566178	<input type="checkbox"/>	Release aid (Per Pair)		215,17
1565005	<input type="checkbox"/>	Original manual wheel adaptation kit Tip: for perfect compatibility of the brakes with the manual wheels, we advise you to order the complete manual wheels as an accessory (1520119 or 1520072) or to equip the original manual wheels with the same coating as the motorized wheels.		215,17
1520119	<input type="checkbox"/>	Complete manual wheels 22 X 1 3/8, gray studded tyre, stainless steel handrail, with 1/2" axle (pair)		412,32
1520072	<input type="checkbox"/>	Complete manual wheels 24 X 1 3/8, gray studded tyre, stainless steel handrail, with 1/2" axle (pair)		412,32
Tablet with joystick in the center:				
1566207	<input type="checkbox"/>	for seat width 380-430 mm		273,93
1566208	<input type="checkbox"/>	for seat width 440-480 mm		273,93
1566206	<input type="checkbox"/>	Fixing kit for mounting the joystick on an existing tablet		160,19
**subject to approval with the chair chosen				



1566200
1566201



1566196



1565669



1565670



1566197



1565836



1566168
1566169



1566177

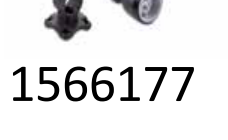

1566179 1566178



1566207
1566208

Alber® e-fix® E36

Electric Power Add-On



Date :

Purchase Order :

Customer Code :

Distributor Stamp:

Assembly by trained service providers or Invacare



Description:

- Full engine with two-wheel drive
- Wheels equipped with pneumatic coating
- Programmable control box.
- 7.5Ah lithium batteries, battery charger.
- Maximum speed 6km/h, 8km/h optional with Pack Mobility Plus
- Wheel diameter: 24". Fixing kit included. 2x150 W motors.
- Assembly carried out by Invacare or trained service providers
- Maximum user weight: 160kg.
- Warranty: 2 years batteries included.

CODE	DESCRIPTION	NC: Not Compatible NC: 9999: not compatible with reference 9999	Euros	
------	-------------	---	-------	--

Assembly of the e-fix® kit

1566181	<input type="checkbox"/> <i>alber e-fix®E36 , 24" wheels (maximum user weight 160kg - wheels equipped with pneumatic coating)</i>		7 135,55	
---------	---	--	----------	--

MANDATORY OPTIONS

1467178	<input type="checkbox"/> Fixing kit for e-fix wheels		271,09	
1584856-EF	<input type="checkbox"/> Installation of the e-fix wheel fixing kit by Invacare (return transport costs not included) <input type="checkbox"/> Average assembly time: 5 working days upon receipt of the chair (In the case of an existing chair, plan to return it to our workshops within 10 days).		323,22	
1593206	<input type="checkbox"/> Anti-tippers with kickstand		355,45	



To determine compatibility:

Wheelchair from the Invacare® group (Action®, kuschall®), please indicate below the serial number of the wheelchair to be equipped.	Wheelchair of all other brands, please send us with this sheet the measurement of the wheelchair to be equipped.
---	--

Test the compatibility of the manual wheelchair using the DIP

Serial number:









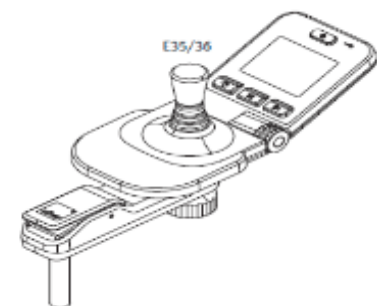

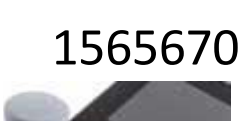

Warning: Pair of original or Alber anti-tip wheels required.
 The brakes will be adjusted to work with the motorized wheels. For your brakes to be functional with manual wheels, we advise you to equip them with the same coating as the motorized wheels.
Wheelbase of the chair subject to change. Avoid all options close to the rear bearings which could interfere with assembly.

Motorized wheel size	
<input type="checkbox"/> 24"	○

ELECTRONIC CONTROLS

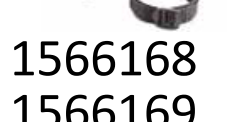
Standard controls			
	<input type="checkbox"/> Joystick right		◆
	<input type="checkbox"/> Joystick left		○
1593361	<input type="checkbox"/> Inward and outward retractable joystick support, multi-adjustable		311,85
	<input type="checkbox"/> Joystick on tablet (see tablet with central position)		○
Third-party controls			
1457755	<input type="checkbox"/> Third-party control, movement of the joystick to the left in the backrest		144,08
1457754	<input type="checkbox"/> Third-person control, movement of the joystick to the right in the backrest		144,08
Intuitive dual control			
1566165	<input type="checkbox"/> Intuitive double control, 1 handle		677,02
	<input type="checkbox"/> Additional manual handle for dual control		○
Batteries			
	<input type="checkbox"/> 7.5 Ah battery (up to 20 km)		◆
1566153	<input type="checkbox"/> Additional 7.5 Ah battery		696,68

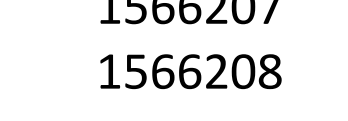

OPTIONS					
1591926	<input type="checkbox"/>	Pack Mobility Plus- Speed up to 8 km/h (not programmable), visual feedback of incoming calls and sms, remote control of the wheelchair Available on Android and iOS (8km/h nc optibox)		347,87	 P30094
1566184	<input type="checkbox"/>	Optibox for e-fix E36		293,84	 1566200 1566201
P30094	<input type="checkbox"/>	Red round and flat contactor		110,90	
1467698	<input type="checkbox"/>	Sensor for standing chair		262,56	
1457743	<input type="checkbox"/>	Support for anti-tipper (only when 1593206 ordered without e-fix®)		146,92	
1566200	<input type="checkbox"/>	24" alber decor spoke guards, individually. Desired quantity:	NC : 1566666, 1566201, 1566203	73,93	 1566196
1566666	<input type="checkbox"/>	24" clear spoke guards per unit. Desired quantity:	NC : 1566201, 1566203	73,93	
1566201	<input type="checkbox"/>	22" alber decor spoke guards per unit. Desired quantity:	NC : 1566203	73,93	 1565669
1566203	<input type="checkbox"/>	22" transparent spoke guards per unit. Desired quantity:		73,93	 1565670
1566196	<input type="checkbox"/>	Ball for flexible joystick diameter 70 mm	NC : 1565669, 1565670	27,49	 1566197
1565669	<input type="checkbox"/>	Ball for special joystick diameter 40 mm	NC : 1565670	25,59	
1565670	<input type="checkbox"/>	T-control for quadriplegic		95,73	 1565836
1566197	<input type="checkbox"/>	Extension for gear selector (for limited hand functions)		48,34	 1566168
1565836	<input type="checkbox"/>	joystick protection		55,92	
1566168	<input type="checkbox"/>	Drum bag with Velcro straps		111,85	 1566169
1566169	<input type="checkbox"/>	Battery bag attachment set	NC : 1566164, 1566163	43,60	
1566164	<input type="checkbox"/>	Fastenings on brace for battery (folding armchairs)	NC : 156163	194,31	 1566164
1566163	<input type="checkbox"/>	Battery axle mounts (non-folding chairs)		160,19	
1566177	<input type="checkbox"/>	Remote charging socket (extension plugged into interface)		102,37	 1566177
1467780	<input type="checkbox"/>	Brake pad extensions		44,55	 1566178
1566179	<input type="checkbox"/>	Clutch release aid, each		109,95	
1566178	<input type="checkbox"/>	Release aid (Per Pair)		215,17	 1565005
1565005	<input type="checkbox"/>	Original manual wheel adaptation kit Tip: for perfect compatibility of the brakes with the manual wheels, we advise you to order the complete manual wheels as an accessory (1520072) or to equip the original manual wheels with the same coating as the motorized wheels.		215,17	
1520072	<input type="checkbox"/>	Complete manual wheels 24 X 1 3/8, gray studded tyre, stainless steel handrail, with 1/2" axle (pair)		412,32	 1566179
Tablet with joystick in the center:					
1566207	<input type="checkbox"/>	for seat width 380-430 mm		273,93	 1566206
1566208	<input type="checkbox"/>	for seat width 440-480 mm		273,93	
1566206	<input type="checkbox"/>	Fixing kit for mounting the joystick on an existing tablet		160,19	