

Invacare® Aviva® RX40 Ultra Low Maxx AA2

Please contact Invacare EU Export Customer Services on :-
 Tel : +33 247 626980; Email : serviceclient_export@invacare.com
 Or visit our website : www.invacare.eu.com



Invacare® Aviva® RX40 Ultra Low Maxx AA2

Rear drive wheelchair



Date :

User name :

Customer Code :

Dealer stamp:



Descriptive :

- **Compactness and manoeuvrability** thanks to:
 - Narrow base from 560 mm
 - Reduced wheelbase
 - Front wheels: 8" or 9"
- **Efficient, comfortable and safe** with as standard
 - 340W motors 4 pole, and 120 A module
 - Adjustable CTC suspension system
 - LED lights system
 - Speed up to 12 km/h
 - 73 Ah batteries and 10A charger
- **High-end design**
 - Metallic colours on frame, rims and backrest
 - Fender for castors and drive wheels
 - Single sided fork

- **Multiposition seat** which includes as standard :

- Seat tilt from 0° to 50°
 - Backrest recliner up to 170°
 - Seat height from 420 mm
- Max. user weight: 136 kg.
 - Warranty : 2 years except batteries and wear parts



Customization Service Invacare Unique

Please indicate your quote number or special manufacturing number :

Indicative Public Rate - Use the online configurator on Invacare Pro to generate quotes or orders free from incompatibilities.

Please make your selection with a cross in the box Standard configuration Free of charge

CODE	DESCRIPTION	NC : Non Compatible NC : 9999 : non compatible with the reference 9999	EUROS
JAA0016	<input type="checkbox"/> AVIVA RX 40 Base Model AP2		11 933,65

CHASSIS AVIVA RX

JAA2810	<input checked="" type="checkbox"/> CHASSIS Narrow (560 mm/22")	NC : 2024	<input checked="" type="checkbox"/>
JAA2830	<input type="checkbox"/> CHASSIS Wide (635 mm/25")	NC : 1244	333,65

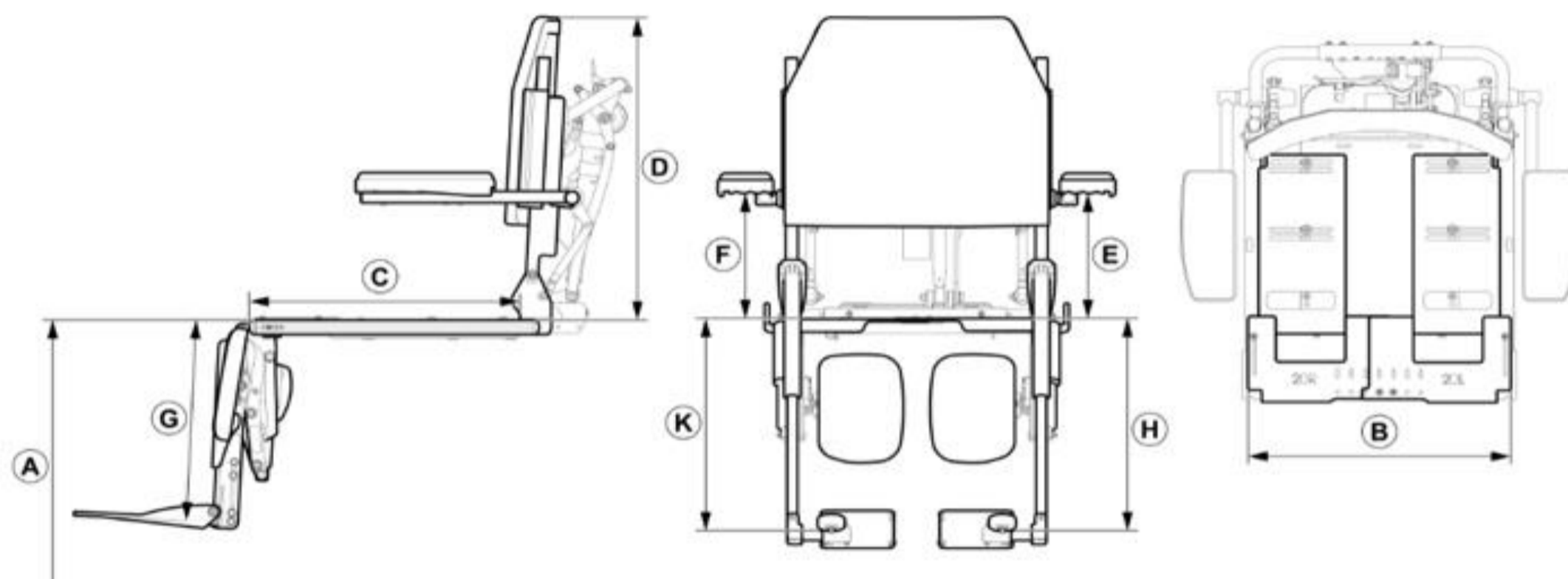

*	Customized settings	Measured from :
A	Seat height	Seat plate to floor
B	Seat width	Front seat plate edge LH to seat plate edge RH
C	Seat depth	Front of seat palte (incl. curve) to bracket of backrest (lowest point)
D	Finished Back Height	Seat plate to top of back
E	Armrest Height LH	Seat plate to top of tube
F	Armreste Height RH	Seat plate to top of tube
G	Centre mount legrest	Top of seat to top of footplate, parrallel to legreste / knee-to-heel lenght
H	Pivot Plus Legrest LH	Top of seat to top of footplate, parrallel to legreste / knee-to-heel lenght
K	Pivot Plus Legrest RH	Top of seat to top of footplate, parrallel to legreste / knee-to-heel lenght

SEATING TYPE

JAA2020	<input type="checkbox"/> Ultra Low Maxx Powered Positioning System		<input checked="" type="checkbox"/>
---------	--	--	-------------------------------------

POWERED POSITIONING OPTIONS

SEAT TILT and combined SEAT TILT & SEAT LIFTER

JAA2052	<input type="checkbox"/> Ultra Low Maxx CG tilt (0 to 50°)	NC : 1401	<input checked="" type="checkbox"/>
JAA2053	<input type="checkbox"/> Ultra Low Maxx CG tilt (0 to 45°) combined with 300 mm seat lifter	NC : 2263, 2264, 1494	2127,01

SEAT HEIGHT SETTING

JAA2856	<input type="checkbox"/> Seat-to-Floor Height 420 mm		<input type="checkbox"/>
JAA2857	<input type="checkbox"/> Seat-to-Floor Height 435 mm	NC : 2054, 2055, 2056	<input type="checkbox"/>
JAA2858	<input type="checkbox"/> Seat-to-Floor Height 460 mm	NC : 2054, 2055, 2056	<input type="checkbox"/>
JAA2859	<input type="checkbox"/> Seat-to-Floor Height 485 mm	NC : 2054, 2055, 2056	<input type="checkbox"/>

ANTERIOR and POSTERIOR TILT OPTIONS				
JAA2057	<input type="checkbox"/>	Ultra Low Maxx CG Tilt Standard Mount		◆
JAX2054	<input type="checkbox"/>	Ultra Low Maxx CG tilt 5° Fixed Anterior Assist mount	NC : 2857, 2858, 2859, 0539, 0549	447,39
JAX2055	<input type="checkbox"/>	Ultra Low Maxx CG tilt 10° Fixed Anterior Assist mount	NC : 2857, 2858, 2859, 0539, 0549	530,81
JAX2056	<input type="checkbox"/>	Ultra Low Maxx CG tilt 5° Fixed Posterior-tilt Assist mount	NC : 0592, 2857, 2858, 2859	447,39
BACKREST RECLINE with ESR				
JAA2060	<input type="checkbox"/>	Powered Recline 90 to 170° , Standard Mount		◆
JAA2063	<input type="checkbox"/>	Powered Recline, 8° Precline mount, 82° to 162°		○
JAA2066	<input type="checkbox"/>	Powered Recline, 30° Precline mount, 60° to 140°		530,81
SEAT DIMENSIONS				
SEAT FRAME WIDTH RANGE				
JAA2021	<input type="checkbox"/>	405 mm - 505 mm (increments of 25 mm) / 16" - 20"	NC : 2030, 2031	◆
JAA2003	<input type="checkbox"/>	480 mm - 555 mm (increments of 25 mm) / 19" - 22"	NC : 2025, 2026, 2027	○
SEAT FRAME DEPTH RANGE				
JAA2008	<input type="checkbox"/>	405 mm - 505 mm (increments of 25 mm) / 16" - 20"	NC : 2040, 2041, 2042	◆
JAA2024	<input type="checkbox"/>	480 mm - 580 mm (increments of 25 mm) / 19" - 23"	NC : 2035, 2036, 2037, 2810	○
SEAT WIDTH SETTING FOR ADJUSTABLE SEAT FRAME				
JAA2025	<input type="checkbox"/>	405 mm / 16"	NC : 2003, 2041, 2042, 2701, 2703, 2705	○
JAA2026	<input type="checkbox"/>	430 mm / 17"	NC : 2003, 2041, 2042, 2701, 2703, 2705	○
JAA2027	<input type="checkbox"/>	455 mm / 18"	NC : 2003, 2701, 2703, 2705	○
JAA2028	<input type="checkbox"/>	480 mm / 19"	NC : 2702, 2704, 2706, 2550	○
JAA2029	<input type="checkbox"/>	505 mm / 20"	NC : 2550, 2702, 2704, 2706	○
JAA2030	<input type="checkbox"/>	530 mm / 21"	NC : 2021, 2035, 2036, 2145, 2702, 2704, 2706	○
JAA2031	<input type="checkbox"/>	555 mm / 22"	NC : 2021, 2035, 2036, 2145, 2702, 2704, 2706	○
SEAT DEPTH SETTING				
JAA2035	<input type="checkbox"/>	405 mm / 16"	NC : 2024, 2030, 2031, Bodypoint belt	○
JAA2036	<input type="checkbox"/>	430 mm / 17"	NC : 2024, 2030, 2031	○
JAA2037	<input type="checkbox"/>	455 mm / 18"	NC : 2024	○
JAA2038	<input type="checkbox"/>	480 mm / 19"		○
JAA2039	<input type="checkbox"/>	505 mm / 20"		○
JAA2040	<input type="checkbox"/>	530 mm / 21"	NC : 2008	○
JAA2041	<input type="checkbox"/>	555 mm / 22"	NC : 2008, 2025, 2026, 2145	○
JAA2042	<input type="checkbox"/>	580 mm / 23"	NC : 2008, 2025, 2026, 2145, 2146	○
SEAT CUSHION				
JAA2144	<input type="checkbox"/>	Matrx Vi Cushion [Mesh fabric]		356,40
JAA2145	<input type="checkbox"/>	Matrx Flo-Tech Lite Black smooth cover, 75 mm thick	NC : 2041, 2042, 2030, 2031	◆
JAA2146	<input type="checkbox"/>	Matrx Flo-tech Contour Black smooth cover, 100 mm thick	NC : 2042	○
JAA2147	<input type="checkbox"/>	Matrx Libra Cushion 90 mm thick		356,40
HIGH BACKS (16 - 24" wide)				
JAA2050	<input type="checkbox"/>	High Back, height 405 mm / 16" [Mesh fabric]		◆
JAA2051	<input type="checkbox"/>	High Back, height 455 mm / 18" [Mesh fabric]		○
JAA2320	<input type="checkbox"/>	High Back, height 505 mm / 20" [Mesh fabric]		○
JAA2550	<input type="checkbox"/>	Matrx Elite Back, height 355mm / 14" / 16 - 18" wide	NC : 2030, 2031, 2028, 2029	○
JAA2551	<input type="checkbox"/>	Matrx Elite Back, height 405 mm / 16"	NC : 2030, 2031	○
JAA2552	<input type="checkbox"/>	Matrx Elite Back, height 455 mm / 18"	NC : 2030, 2031	○
JAA2553	<input type="checkbox"/>	Matrx Elite Back, height 505 mm / 20"	NC : 2030, 2031	○
JAA2554	<input type="checkbox"/>	Matrx Elite HD Back, height 405 mm / 16"	NC : 2025, 2026, 2027, 2028, 2029	638,86
JAA2555	<input type="checkbox"/>	Matrx Elite HD Back, height 505 mm / 20"	NC : 2025, 2026, 2027, 2028, 2029	638,86
JAA2556	<input type="checkbox"/>	Matrx Elite TR Back, height 405 mm / 16" [Mesh fabric]	NC : 2030, 2031	638,86
JAA2557	<input type="checkbox"/>	Matrx Elite TR Back, height 455 mm / 18" [Mesh fabric]	NC : 2030, 2031	638,86
JAA2177	<input type="checkbox"/>	Matrx Elite TR Back, height 505 mm / 20" [Mesh fabric]	NC : 2030, 2031	638,86
JAA2563	<input type="checkbox"/>	Matrx Elite TR HD Back, height 505 mm / 20" [Mesh fabric]	NC : 2025, 2026, 2027, 2028, 2029	638,86



JAA2558	<input type="checkbox"/>	Matrx Elite Deep Back, height 405 mm / 16" [Mesh fabric]	NC : 2343, 2345, 2043, 2045, 2344, 2346, 2044, 2046, 2049, 2030, 2031	638,86
JAA2559	<input type="checkbox"/>	Matrx Elite Deep Back, height 455 mm / 18" [Mesh fabric]	NC : 2343, 2345, 2043, 2045, 2344, 2346, 2044, 2046, 2049, 2030, 2031	638,86
JAA2178	<input type="checkbox"/>	Matrx Elite Deep Back, height 505 mm / 20" [Mesh fabric]	NC : 2343, 2345, 2043, 2045, 2344, 2346, 2044, 2046, 2049, 2030, 2031	638,86
JAA2174	<input type="checkbox"/>	Matrx PB Back, height 405 mm / 16" [Mesh fabric]	NC : 2028, 2029, 2030, 2031	759,24
JAA2175	<input type="checkbox"/>	Matrx PB Back, height 505 mm / 20" [Mesh fabric]	NC ; 2028, 2029, 2030, 2031	759,24
JAA2560	<input type="checkbox"/>	Matrx PB Deep Back, height 405mm / 16"	NC : 2343, 2345, 2043, 2045, 2344, 2346, 2044, 2046, 2049, 2028, 2029, 2030, 2031	759,24
JAA2561	<input type="checkbox"/>	Matrx PB Deep Back, height 505 mm / 20"	NC : 2343, 2345, 2043, 2045, 2344, 2346, 2044, 2046, 2049, 2028, 2029, 2030, 2031	759,24
JAA2562	<input type="checkbox"/>	Matrx Elite Deep HD Back, height 505 mm / 20"	NC : 2343, 2345, 2043, 2045, 2344, 2346, 2044, 2046, 2049, 2025, 2026, 2027, 2028, 2029	638,86
FINISHED BACK HEIGHT				
JAA2506	<input type="checkbox"/>	505 mm / 20"		○
JAA2501	<input type="checkbox"/>	535 mm / 21"		○
JAA2070	<input type="checkbox"/>	555 mm / 22"		○
JAA2071	<input type="checkbox"/>	585 mm / 23"		○
JAA2072	<input type="checkbox"/>	610 mm / 24"		○
JAA2073	<input type="checkbox"/>	635 mm / 25"		○
JAA2074	<input type="checkbox"/>	660 mm / 26"		○
JAA2502	<input type="checkbox"/>	685 mm / 27"		○
ARMRESTS FOR ESR RECLINE SYSTEM				
JAA2095	<input type="checkbox"/>	Cantilever Flip-Back Arm, width, height and angle adjustable, 240 - 330 mm (9.5" - 13")		◆
JAA2096	<input type="checkbox"/>	Cantilever Flip-Back Arm, width, height and angle adjustable, 340 - 405 mm (13.5-16")		○
JAA2097	<input type="checkbox"/>	Two-post Recline Arm, Flip Back, adjustable height 230 - 330 mm (9-13")		302,37
LEFT HAND				
JAA2012	<input type="checkbox"/>	Desk arm pad with startex cover visco foam [255mm]; 40 mm thick	NC : 2080	◆
JAA2013	<input type="checkbox"/>	Full length arm pad with startex cover visco foam [355mm], 40 mm thick	NC : 2080	○
JAA2014	<input type="checkbox"/>	Ergonomic arm trough; 30 mm thick	NC : Shelf, left elbow rest	163,98
RIGHT HAND				
JAA2016	<input type="checkbox"/>	Desk arm pad with startex cover visco foam [255mm]; 40 mm thick	NC : 2083	◆
JAA2017	<input type="checkbox"/>	Full length arm pad with startex cover visco foam [355mm]; 40 mm thick	NC : 2083	○
JAA2018	<input type="checkbox"/>	Ergonomic arm trough, 30 mm thick	NC : Shelf, right elbow rest	163,98
ARM PAD ACCESSORIES & MOUNTING OPTIONS				
JAA2080	<input type="checkbox"/>	Flat Hand Pad Left	NC : 2012, 2013	158,29
JAA2083	<input type="checkbox"/>	Flat Hand Pad Right	NC : 2016, 2017	158,29
MULTI-AXIS UPPER EXTREMITY SUPPORTS				
JAA2082	<input type="checkbox"/>	Multi Axis Upper Extremity Support (MACES) Left, lowest armpad height will be increased by 43 mm		309,95
JAA2085	<input type="checkbox"/>	Multi Axis Upper Extremity Support (MACES) Right, lowest armpad height will be increased by 43 mm		309,95
E -Height setting: ARMREST LH - SEAT PAN TO TOP OF THE TUBE				
Custom Setting :				
<input type="checkbox"/> 290 mm				◆
<input type="checkbox"/> 230 mm <input type="checkbox"/> 240 mm <input type="checkbox"/> 250 mm <input type="checkbox"/> 260 mm <input type="checkbox"/> 270 mm				○
<input type="checkbox"/> 280 mm <input type="checkbox"/> 300 mm <input type="checkbox"/> 310 mm <input type="checkbox"/> 320 mm <input type="checkbox"/> 330 mm				○
<input type="checkbox"/> 340 mm <input type="checkbox"/> 350 mm <input type="checkbox"/> 360 mm <input type="checkbox"/> 370 mm <input type="checkbox"/> 380 mm				○
<input type="checkbox"/> 390 mm <input type="checkbox"/> 405 mm				○
F - Height setting: ARMREST RH SEAT PAN TO TOP OF THE TUBE				
Custom Setting :				
<input type="checkbox"/> 290 mm				◆
<input type="checkbox"/> 230 mm <input type="checkbox"/> 240 mm <input type="checkbox"/> 250 mm <input type="checkbox"/> 260 mm <input type="checkbox"/> 270 mm				○
<input type="checkbox"/> 280 mm <input type="checkbox"/> 300 mm <input type="checkbox"/> 310 mm <input type="checkbox"/> 320 mm <input type="checkbox"/> 330 mm				○
<input type="checkbox"/> 340 mm <input type="checkbox"/> 350 mm <input type="checkbox"/> 360 mm <input type="checkbox"/> 370 mm <input type="checkbox"/> 380 mm				○
<input type="checkbox"/> 390 mm <input type="checkbox"/> 405 mm				○

ELBOW BLOCK LEFT: PADS				
JAA2347	<input type="checkbox"/>	Elbow Block XS (110 mm wide x 83 mm high)	NC : 2014	295,73
JAA2348	<input type="checkbox"/>	Elbow Block S (135 mm wide x 90 mm high)	NC : 2014	295,73
JAA2349	<input type="checkbox"/>	Elbow Block M (145 mm wide x 95 mm high)	NC : 2014	295,73
JAA2350	<input type="checkbox"/>	Elbow Block L (165 mm wide x 110 mm high)	NC : 2014	295,73
ELBOW BLOCK LEFT: MOUNTING HARDWARE				
JAA2361	<input type="checkbox"/>	Vertical 3"/ Horizontal 5"		○
JAA2362	<input type="checkbox"/>	Vertical 3"/ Horizontal 7"		○
JAA2363	<input type="checkbox"/>	Vertical 5"/ Horizontal 5"		○
JAA2364	<input type="checkbox"/>	Vertical 5"/ Horizontal 7"		○
ELBOW BLOCKS RIGHT: PADS				
JAA2351	<input type="checkbox"/>	Elbow Block XS (110 mm wide x 83 mm high)	NC : 2018	295,73
JAA2352	<input type="checkbox"/>	Elbow Block S (135 mm wide x 90 mm high)	NC : 2018	295,73
JAA2353	<input type="checkbox"/>	Elbow Block M (145 mm wide x 95 mm high)	NC : 2018	295,73
JAA2354	<input type="checkbox"/>	Elbow Block L (165 mm wide x 110 mm high)	NC : 2018	295,73
ELBOW BLOCK RIGHT: MOUNTING HARDWARE				
JAA2371	<input type="checkbox"/>	Vertical 3"/ Horizontal 5"		○
JAA2372	<input type="checkbox"/>	Vertical 3"/ Horizontal 7"		○
JAA2373	<input type="checkbox"/>	Vertical 5"/ Horizontal 5"		○
JAA2374	<input type="checkbox"/>	Vertical 5"/ Horizontal 7"		○
HIP SUPPORTS				
JAA2184	<input type="checkbox"/>	Hip Support LH, Quick Release, pad size 140 x 100 mm	NC : Bodypoint belt	290,05
JAA2114	<input type="checkbox"/>	Hip Support LH, Quick Release, pad size 180 x 150 mm	NC : Bodypoint belt	290,05
JAA2186	<input type="checkbox"/>	Hip Support LH, Quick Release, pad size 230 x 100 mm	NC : Bodypoint belt	290,05
JAA2188	<input type="checkbox"/>	Hip Support LH, Quick Release, pad size 330 x 100 mm	NC : Bodypoint belt	290,05
JAA2185	<input type="checkbox"/>	Hip Support RH, Quick Release, pad size 140 x 100 mm	NC : Bodypoint belt	290,05
JAA2115	<input type="checkbox"/>	Hip Support RH, Quick Release, pad size 180 x 150 mm	NC : Bodypoint belt	290,05
JAA2187	<input type="checkbox"/>	Hip Support RH, Quick Release, pad size 230 x 100 mm	NC : Bodypoint belt	290,05
JAA2189	<input type="checkbox"/>	Hip Support RH, Quick Release, pad size 330 x 100 mm	NC : Bodypoint belt	290,05
MOUNTING HARDWARE FOR HIP SUPPORTS				
JAA2164	<input type="checkbox"/>	Mounting hardware for hip supports (6,1" / 155 mm high)		○
JAA2165	<input type="checkbox"/>	Mounting hardware for hip supports (8,1" / 206 mm high)		○
HEADREST AND MOUNTING HARDWARE				
JAA2324	<input type="checkbox"/>	Elan Standard Pad 255 mm / 10" wide w/standard cover (ESP26), complete with Elan Headrest Hardware (MEHW)	NC : 2255, 2230, 2247	◆
JAA2325	<input type="checkbox"/>	Elan Occipital Pad 230x180 mm / 9"x7" w/standard cover (EOP23), complete with Elan Headrest Hardware (MEHW)	NC : 2255, 2230, 2247	262,56
JAA1495	<input type="checkbox"/>	Head Control or equivalent Headrest, provided independently from this order	NC : 2229	○
LATERAL SUPPORTS				
JAA2343	<input type="checkbox"/>	Lateral Support Maxx Style Quick Release, pad size [110 mm wide x 83 mm high] LH	NC : 2558, 2559, 2178, 2560, 2561, 2562	290,05
JAA2345	<input type="checkbox"/>	Lateral Support Maxx Style Quick Release, pad size [135 mm wide x 90 mm high] LH	NC : 2558, 2559, 2178, 2560, 2561, 2562	290,05
JAA2043	<input type="checkbox"/>	Lateral Support Maxx Style Quick Release, pad size [145 mm wide x 95 mm high] LH	NC : 2558, 2559, 2178, 2560, 2561, 2562	290,05
JAA2045	<input type="checkbox"/>	Lateral Support Maxx Style Quick Release, pad size [165 mm wide x 110 mm high] LH	NC : 2558, 2559, 2178, 2560, 2561, 2562	290,05
JAA2344	<input type="checkbox"/>	Lateral Support Maxx Style Quick Release, pad size [110 mm wide x 83 mm high] RH	NC : 2558, 2559, 2178, 2560, 2561, 2562	290,05
JAA2346	<input type="checkbox"/>	Lateral Support Maxx Style Quick Release, pad size [135 mm wide x 90 mm high] RH	NC : 2558, 2559, 2178, 2560, 2561, 2562	290,05
JAA2044	<input type="checkbox"/>	Lateral Support Maxx Style Quick Release, pad size [145 mm wide x 95 mm high] RH	NC : 2558, 2559, 2178, 2560, 2561, 2562	290,05
JAA2046	<input type="checkbox"/>	Lateral Support Maxx Style Quick Release, pad size [165 mm wide x 110 mm high] RH	NC : 2558, 2559, 2178, 2560, 2561, 2562	290,05
JAA2049	<input type="checkbox"/>	Additional telescopic link for Maxx Style lateral support, 25 mm, Pair	NC : 2558, 2559, 2178, 2560, 2561, 2562	106,16
LEGRESTS / FOOTRESTS				
Central legrest adjustable in inclination with calf supports				
WARNING: Possible conflict between footrests and front wheels - favour the wide chassis				
JAA0586	<input type="checkbox"/>	Centre mount legrest, angle settable Length: 310 - 410 mm	NC : 0517, 1244	◆
JAA0589	<input type="checkbox"/>	LNx Power centre mount legrest, length compensating; Length: 340 - 410 mm	NC : 2263, 2264, 1244	1 712,80
JAX0592	<input type="checkbox"/>	LNx Power centre mount legrest with telescoping foot platform (lowers to the ground; Length: 380 - 419 mm) Selectable length depends on STF height. Custom-made, requires customized setting!	NC : 0559, 0516, 0517, 2056, 2263, 2264, 2365, 1244	3 002,84



2325

FOOTPLATES / FOOT PLATFORM				
JAA2365	<input type="checkbox"/>	Angle & width adjustable footplates S (127 W x 190 mm D / 5"x7.5")	NC : 0592	○
JAA0559	<input type="checkbox"/>	Angle & width adjustable footplates M (140 W x 240 mm D / 5.5"x9.5")	NC : 0592	◆
JAA0516	<input type="checkbox"/>	Angle & width adjustable footplates L (150 W x 290 mm D / 6"x11.5)	NC : 0592	124,17
JAA0517	<input type="checkbox"/>	Angle adjustable foot platform M (305 W x 275 mm D / 12"x10.75")	NC : 0592, 0586	124,17
G -Height setting: CENTRE MOUNT LEGREST, OPTIONS 0586 & 0589- SEAT PAN TO FOOTPLATE				
Custom setting :				
<input type="checkbox"/> 375 mm				◆
<input type="checkbox"/> 310 mm <input type="checkbox"/> 325 mm <input type="checkbox"/> 335 mm <input type="checkbox"/> 345 mm				○
<input type="checkbox"/> 355 mm <input type="checkbox"/> 364 mm <input type="checkbox"/> 385 mm <input type="checkbox"/> 410 mm				○
G -Height setting: CENTRE MOUNT LEGREST with TELESCOPING FOOT PLATFORM - SEAT PAN TO FOOTPLATE				
Custom setting :				
<input type="checkbox"/> 380 mm <input type="checkbox"/> 393 mm <input type="checkbox"/> 406 mm <input type="checkbox"/> 419 mm				○
PIVOT PLUS LEGRESTS; LH				
special	<input type="checkbox"/>	Manual leg rest 0° to 80°, left		○
manufacturing	<input type="checkbox"/>	Manual ergonomic leg rest 0° to 80°, left		95,73
JAA0539	<input type="checkbox"/>	Ergonomic electric leg rest from 0° to 80°, left	NC : 2054, 2055	343,13
PIVOT PLUS LEGRESTS; RH				
special	<input type="checkbox"/>	Manual leg rest 0° to 80°, right		○
manufacturing	<input type="checkbox"/>	Manual ergonomic leg rest 0° to 80°, right		95,73
JAA0549	<input type="checkbox"/>	Ergonomic electric leg rest from 0° to 80°, right	NC : 2054, 2055	343,13
INDIVIDUAL FOOTPLATE TYPE; LH				
JAA0509	<input type="checkbox"/>	Tilt adjustable		○
JAA0511	<input type="checkbox"/>	Angle and depth adjustable Footplate LH		◆
INDIVIDUAL FOOTPLATE TYPE; RH				
JAA0506	<input type="checkbox"/>	Tilt adjustable		○
JAA0508	<input type="checkbox"/>	Angle and depth adjustable Footplate RH		◆
H - Height setting: PIVOT PLUS LEGREST LH SEAT PAN TO FOOTPLATE				
Custom setting :				
<input type="checkbox"/> 380 mm				◆
<input type="checkbox"/> 270 mm <input type="checkbox"/> 280 mm <input type="checkbox"/> 290 mm				○
<input type="checkbox"/> 300 mm <input type="checkbox"/> 310 mm <input type="checkbox"/> 320 mm				○
<input type="checkbox"/> 330 mm <input type="checkbox"/> 340 mm <input type="checkbox"/> 350 mm				○
<input type="checkbox"/> 360 mm <input type="checkbox"/> 370 mm <input type="checkbox"/> 390 mm				○
<input type="checkbox"/> 400 mm <input type="checkbox"/> 410 mm <input type="checkbox"/> 420 mm				○
<input type="checkbox"/> 430 mm				○
K -Height setting: PIVOT PLUS LEGREST RH-SEAT PAN TO FOOTPLATE				
Custom setting :				
<input type="checkbox"/> 380 mm				◆
<input type="checkbox"/> 270 mm <input type="checkbox"/> 280 mm <input type="checkbox"/> 290 mm				○
<input type="checkbox"/> 300 mm <input type="checkbox"/> 310 mm <input type="checkbox"/> 320 mm				○
<input type="checkbox"/> 330 mm <input type="checkbox"/> 340 mm <input type="checkbox"/> 350 mm				○
<input type="checkbox"/> 360 mm <input type="checkbox"/> 370 mm <input type="checkbox"/> 390 mm				○
<input type="checkbox"/> 400 mm <input type="checkbox"/> 410 mm <input type="checkbox"/> 420 mm				○
<input type="checkbox"/> 430 mm				○
REMOTES LINX				
LINX PRIMARY REMOTES with proportional Joystick + BRACKETS				
JAA2204	<input type="checkbox"/>	Remote LiNX DLX-REM216 = Drive, Actuators & Lights	NC : 2231, 2232, 2229, 2233, 2230, 2247, 2257, 2240, 2243, 2271, 2255, 2256, 2270, 2272, 2209, 2210	◆
JAA2205	<input type="checkbox"/>	Rehab Remote LiNX, touch-screen user interface DLX-REM400	NC : 2209, 2210	575,36
JAA2206	<input type="checkbox"/>	Rehab Remote LiNX without joystick for alternative access users DLX-REM500	NC : 2270, 1207, 1208, 1707, 1708, 2075, 2076, 2227, 2228	1 091,94
REM400 TOGGLE OPTION				
JAA2270	<input type="checkbox"/>	Assignable Toggle Switch Module f. REM400 (DLX-SW400TGL)	NC : 2204, 2206	340,28



PRIMARY REMOTE AND DISPLAY MOUNTING POSITION				
JAA1207	<input type="checkbox"/>	Standard Bracket RH	NC : 2206, 2285, 2283, 2287, 2207, 2265, 2275, 2235, 2267, 2241, 1404, 2311	○
JAA1208	<input type="checkbox"/>	Standard Bracket LH	NC : 2206, 2286, 2284, 2288, 2208, 2266, 2276, 2236, 2268, 2242, 1405, 2310	○
JAA1707	<input type="checkbox"/>	Escamotable à droite + réglable en hauteur, renforcé	NC : 2206, 2285, 2283, 2287, 2207, 2265, 2275, 2335, 2267, 2241, 1404, 2311	◆
JAA1708	<input type="checkbox"/>	Swing Away Bracket RH	NC : 2206, 2286, 2284, 2288, 2208, 2266, 2276, 2236, 2268, 2242, 1405, 2310	○
JAA1709	<input type="checkbox"/>	Maxx resolve , swing away in/out - RH	NC 2206, 2285, 2283, 2287, 2207, 2265, 2275, 1404	236,97
JAA1710	<input type="checkbox"/>	Maxx resolve , swing away in/out - LH	NC 2206, 2286, 2284, 2288, 2208, 2266, 2276, 1405	236,97
JAA2209	<input type="checkbox"/>	Swing away RH, multi-adjustable	NC : 2204, 2205, 2285, 2283, 2287, 2207, 2265, 2275, 2235, 2267, 2241, 1415, 2217, 1404, 2311	○
JAA2210	<input type="checkbox"/>	Swing away LH, multi-adjustable	NC : 2204, 2205, 2286, 2284, 2288, 2208, 2266, 2276, 2236, 2268, 2242, 1339, 2218, 1405, 2310	○
PW-4005	<input type="checkbox"/>	Option 2209/2210 with mounting rod for REM500 extended by 200 mm		Special manufacturing On demand
JAA2075	<input type="checkbox"/>	Swing Away + height / width adjust. Mount on RH for user, Quad link design	NC : 2285, 2283, 2287, 2207, 2265, 2275, 2235, 2267, 2241, 1404, 1415	232,23
JAA2076	<input type="checkbox"/>	Swing Away + height / width adjust. Mount on LH for user, Quad link design	NC : 2286, 2284, 2288, 2208, 2266, 2276, 2236, 2268, 2242, 1405, 1339	232,23
JAA2213	<input type="checkbox"/>	Centre Mount, swing-away to RH, Nucleus	NC : 2285, 2283, 2287, 2207, 2265, 2275, 2235, 2267, 2241, 2217, 1404, 1405, 1415	563,98
JAA2214	<input type="checkbox"/>	Centre Mount, swing-away to LH, Nucleus	NC : 2286, 2284, 2288, 2208, 2266, 2276, 2236, 2268, 2242, 2218, 1404, 1405, 1339	563,98
JAA2227	<input type="checkbox"/>	Bracket RH, mounted for Attendant	NC : 2219, 1221, 2206, 1287	160,19
JAA2228	<input type="checkbox"/>	Bracket LH, mounted for Attendant	NC : 2219, 1222, 2206, 1286	160,19
JAX2239	<input type="checkbox"/>	Individual mounting option per request (Special)		On demand
DUAL CONTROL LiNX + BRACKETS				
JAA2219	<input type="checkbox"/>	Compact Dual Control LiNX (DLX-ACU200)	NC : 1221, 1222, 2227, 2228	1 144,08
JAA2245	<input type="checkbox"/>	Invacare LiNX IDC Dual control	NC : 2259, 2260, 2069	1 637,91
JAA2259	<input type="checkbox"/>	Bracket RH, Attendant	NC : 1287, 2245	○
JAA2260	<input type="checkbox"/>	Bracket LH, Attendant	NC : 1286, 2245	○
JAA1221	<input type="checkbox"/>	Bracket RH, detachable	NC : 1287, 2219, 2227	○
JAA1222	<input type="checkbox"/>	Bracket LH, detachable	NC : 1286, 2219, 2228	○
If several joysticks (or REM500 + another joystick) must be mounted in the central position (2213/2214), select option 2215.				
LiNX - COMPACT REMOTES + BRACKETS				
JAA2231	<input type="checkbox"/>	Proportional Compact Remote DLX-CR400	NC : 2204	1 191,47
JAA2232	<input type="checkbox"/>	Proportional Compact Remote Low Force DLX-CR-400LF	NC : 2204	1 312,80
JAA2207	<input type="checkbox"/>	RH Mount	NC : 1207, 1707, 2075, 2209, 2213, 2217, 1404, 2311	○
JAA2208	<input type="checkbox"/>	LH Mount	NC : 1208, 1708, 2076, 2210, 2214, 2218, 1405, 2310	○
JAA2265	<input type="checkbox"/>	Centre Mount, swing-away to RH (Nucleus)	NC : 1207, 1707, 2075, 2209, 2213, 2217, 1404, 1405, 1415	717,54
JAA2266	<input type="checkbox"/>	Centre Mount, swing-away to LH (Nucleus)	NC : 1208, 1708, 2076, 2210, 2214, 2218, 1404, 1405, 1339	717,54
JAX2215	<input type="checkbox"/>	Individual mounting option per request (Special)		On demand
ALTERNATIVE JOYSTICKS + INPUTS + BRACKETS				
CHIN CONTROL + BRACKETS				
JAA2229	<input type="checkbox"/>	Proportional Chin Joystick (ASL138)	NC : 1495, 2204, 2230, 2247, 2233, 2257, 2240	3 011,37
JAA1289	<input type="checkbox"/>	Swing Away Bracket RH, side manual (ASL628)		○
JAA1288	<input type="checkbox"/>	Swing Away Bracket LH, side manual (ASL628)		○
JAX1287	<input type="checkbox"/>	Swing Away Bracket RH, powered	NC : 2227, 2259, 1221	1 445,50
JAX1286	<input type="checkbox"/>	Swing Away Bracket LH, powered	NC : 2228, 2260, 1222	1 445,50

NEW

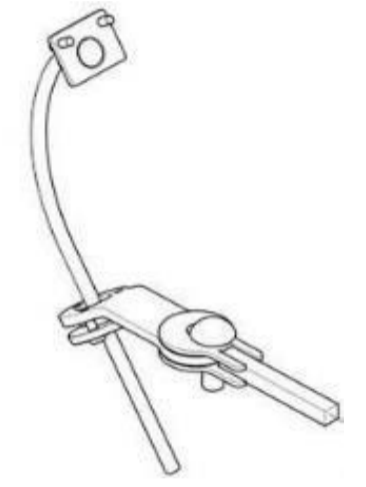

2209
2210



2219







2245



2231
2232

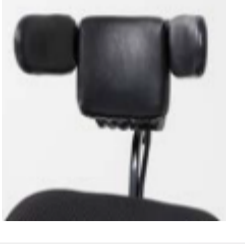

1288 1286
1289 1287

HEAD CONTROL ATOM Technology					
JAA2230	<input type="checkbox"/>	Head Control with ultrasonic proximity sensors (ATOM, ASL104) with standard wings M3	NC : 2204, 2229, 2233, 2324, 2325, 2257, 2240	5 648,34	 2230
JAA2247	<input type="checkbox"/>	Head Control with ultrasonic proximity sensors (PROTON, ASL104P) with PROTON wings	NC : 2204, 2229, 2233, 2324, 2325, 2257, 2240	5 648,34	 2247
FOUR-SWITCH PROXIMITY ARRAY (with ATOM Technology)					
JAA2257	<input type="checkbox"/>	Four-Switch Proximity Array (ASL106)	NC : 2204, 2229, 2230, 2247, 2233, 2240	6 129,86	
JAA2275	<input type="checkbox"/>	Centre Mount, swing-away to RH, Nucleus Incl. Eclipse Tray ASL619, 360x180 mm)	NC : 1207, 1707, 2075, 2209, 2213, 2217, 1404, 1405, 1415	○	
JAA2276	<input type="checkbox"/>	Centre Mount, swing-away to LH, Nucleus Incl. Eclipse Tray ASL619, 360x180 mm)	NC : 1208, 1708, 2076, 2210, 2214, 2218, 1404, 1405, 1339	○	
JAX2269	<input type="checkbox"/>	Individual mounting option per request (Special)		On demand	 2250
WIRELESS ACCESSORIES FOR ATOM					
JAA2250	<input type="checkbox"/>	Wireless Mouse Emulator (ASL558)		1 505,21	
LiNX - PROPORTIONAL REMOTES WITH TPI / INPUTS & BRACKETS					
JAA2233	<input type="checkbox"/>	MEC Proportional Joystick (Micro Extremity Control ASL130)	NC : 2204, 2229, 2230, 2247, 2257	3 366,82	 2233
JAA2240	<input type="checkbox"/>	Proportional Heavy Duty Remote Joystick w mode switch (ASL133)	NC : 2204, 2229, 2230, 2247, 2257	3 366,82	
JAA2285	<input type="checkbox"/>	Tray Mount RH (100x150 mm)	NC : 1207, 1707, 2075, 2209, 2213, 2217, 1415, 1404, 1405, 2311	717,54	
JAA2286	<input type="checkbox"/>	Tray Mount LH (100x150 mm)	NC : 1208, 1708, 2076, 2210, 2214, 2218, 1339, 1404, 1405, 2311	717,54	
JAA2283	<input type="checkbox"/>	Centre Mount, swing-away to RH, Nucleus	NC : 1207, 1707, 2075, 2209, 2213, 2217, 1415, 1404, 1405, 2311	○	
JAA2284	<input type="checkbox"/>	Centre Mount, swing-away to LH, Nucleus	NC : 1208, 1708, 2076, 2210, 2214, 2218, 1339, 1404, 1405, 2311	○	
JAA2287	<input type="checkbox"/>	Centre Mount, swing-away to RH, Nucleus	NC : 1207, 1707, 2075, 2209, 2213, 2217, 1415, 1404, 1405, 2311	717,54	
JAA2288	<input type="checkbox"/>	Centre Mount, swing-away to LH, Nucleus	NC : 1208, 1708, 2076, 2210, 2214, 2218, 1339, 1404, 1405, 2311	717,54	
JAX2289	<input type="checkbox"/>	Individual mounting option per request (Special)		On demand	
PEDIATRIC COMPACT					
JAA2243	<input type="checkbox"/>	Proportional Pediatric Compact (ASL132), incl. Input Module	NC : 2271, 2204, 2255, 2256	3 030,33	
JAA2235	<input type="checkbox"/>	Tray Mount RH (100x150 mm)	NC : 1207, 1707, 2075, 2209, 2213, 2217, 1415, 1404, 1405, 2311	○	
JAA2236	<input type="checkbox"/>	Tray Mount LH (100x150 mm)	NC : 1208, 1708, 2076, 2210, 2214, 2218, 1339, 1404, 1405, 2311	○	
JAA2267	<input type="checkbox"/>	Centre Mount, swing-away to RH, Nucleus	NC : 1207, 1707, 2075, 2209, 2213, 2217, 1415, 1404, 1405, 2311	○	
JAA2268	<input type="checkbox"/>	Centre Mount, swing-away to LH, Nucleus	NC : 1208, 1708, 2076, 2210, 2214, 2218, 1339, 1404, 1405, 2311	○	
JAA2241	<input type="checkbox"/>	Centre Mount, swing-away to RH, Nucleus	NC : 1207, 1707, 2075, 2209, 2213, 2217, 1415, 1404, 1405, 2311	717,54	
JAA2242	<input type="checkbox"/>	Centre Mount, swing-away to LH, Nucleus	NC : 1208, 1708, 2076, 2210, 2214, 2218, 1339, 1404, 1405, 2311	717,54	
JAX2277	<input type="checkbox"/>	Individual mounting option per request (Special)		On demand	
SIP'N PUFF HEAD CONTROL					
JAA2255	<input type="checkbox"/>	Sip'n Puff Head Control (ASL109), includes Input Module and Lip Switch (ASL 301 LIP)	NC : 2271, 2204, 2324, 2325, 2243	6 731,75	 2255 2256
SIP'N PUFF CONTROL & INPUT MODULE					
JAA2256	<input type="checkbox"/>	Sip'n Puff Control includes Sip'n Puff kit, Lip Switch ASL301LIP and Input module	NC : 2271, 2203, 2204, 2243	6 731,75	
LiNX INTERFACE OPTIONS (mounted & connected)					
JAA2271	<input type="checkbox"/>	Input Module DLX-IN500-A (sub D, Sip'n Puff)	NC : 2243, 2255, 2256, 2204	507,11	

LiNX 10-WAY SWITCH			
JAA2251	<input type="checkbox"/>	10-Way Switch DLX-SW10-A for direct Powered Seating Access	530,81
JAA2217	<input type="checkbox"/>	Bracket RH, mounted for user	NC : 1415, 2207, 2287, 2283, 2285, 2275, 2213, 2209, 2265, 2267, 2241, 2235, 1404
JAA2218	<input type="checkbox"/>	Bracket LH, mounted for user	NC : 1339, 2208, 2288, 2284, 2286, 2276, 2214, 2210, 2266, 2268, 2242, 2236, 1405
JAA2226	<input type="checkbox"/>	For attendant, mounted on back shroud	○
JAA2225	<input type="checkbox"/>	Without mounting	○
TOGGLES / BUTTONS			
Special manufacturing	<input type="checkbox"/>	Two-Way Toggle - direct access to the seat rocker	290,05
	<input type="checkbox"/>	2-way Button - direct access to the seat rocker	290,05
JAA2263	<input type="checkbox"/>	Four-Way Toggle - direct control for tilt & recline	NC : 2053, 0577, 0584, 0589, 0592
JAA2264	<input type="checkbox"/>	Four-Way Button - direct control for tilt & recline	NC : 2053, 0577, 0584, 0589, 0592
JAA2279	<input type="checkbox"/>	RH Mount (of Toggle/Button)	○
JAA2280	<input type="checkbox"/>	LH Mount (of Toggle/Button)	○
JAA2278	<input type="checkbox"/>	Without mounting	○
LiNX ACCESSORIES			
USB CHARGER PORT			
JAA2253	<input type="checkbox"/>	USB Charger Port DLX-USB02-A	NC : Bodypoint belt
JAA2281	<input type="checkbox"/>	RH Mount (of Charger Port)	○
JAA2282	<input type="checkbox"/>	LH Mount (of Charger Port)	○
REMOTE STOP SWITCH			
JAA2258	<input type="checkbox"/>	Remote Stop Switch (ASL504)	831,28
INPUT200 MODULE			
JAA2273	<input type="checkbox"/>	IN200 Module (Jack port for external power button + control inputs via DB9)	349,76
OUTPUT MODULE			
JAA2272	<input type="checkbox"/>	LiNX Output Module (DLX-OUT500)	NC : 2204
FURTHER LiNX COMPONENTS / ACCESSORIES			
JAA2300	<input type="checkbox"/>	To be enclosed only	○
JAX2301	<input type="checkbox"/>	To be connected and programmed (Special)	On demand
BUDDY BUTTONS			
JAA1685	<input type="checkbox"/>	Red Buddy Button	130,81
JAA1686	<input type="checkbox"/>	Yellow Buddy Button	130,81
JAA1687	<input type="checkbox"/>	Green Buddy Button	130,81
JAA1690	<input type="checkbox"/>	Blue Buddy Button	130,81
EGG SWITCH			
JAA2254	<input type="checkbox"/>	Egg Switch, black	103,32
PIKO BUTTONS			
JAA1711	<input type="checkbox"/>	Red Piko Button	130,81
JAA1712	<input type="checkbox"/>	Yellow Piko Button	130,81
JAA1713	<input type="checkbox"/>	Green Piko Button	130,81
JAA1714	<input type="checkbox"/>	Orange Piko Button	130,81
JAA1715	<input type="checkbox"/>	Blue Piko Button	130,81
JAA1716	<input type="checkbox"/>	Black Piko Button	130,81
BODYPOINT JOYSTICK KNOBS			
JAA2721	<input type="checkbox"/>	3 inch U-Shaped, Joystick Handle, Bodypoint PC101A	100,00
JAA2722	<input type="checkbox"/>	4 inch U-Shaped, Joystick Handle, Bodypoint PC102A	100,00
JAA2723	<input type="checkbox"/>	Domed Rubber, Joystick Handle, Bodypoint PC107A	100,00
JAA2724	<input type="checkbox"/>	Mushroom Grooved, Joystick Handle, Bodypoint PC110A	100,00
SWITCH ADAPTER			
JAA1681	<input type="checkbox"/>	5:1 Switch Adapter (9-pin sub D to 5 jack ports)	144,08



2251



2263



2253



2258



2272

2721
2722









2723



2724



1681

WHEELBASE DETAILS						
COLOURS						
JAA2871	<input type="checkbox"/>	Mid range - Black/Anthracite Shroud		-284,36		
JAA2872	<input type="checkbox"/>	Mid range - Silver Shroud		-284,36	2871	2872
JAA2873	<input type="checkbox"/>	Mid range - Bengal Red Shroud		-284,36		
JAA2874	<input type="checkbox"/>	Mid range - Mercury Blue Shroud		-284,36	2873	2874
JAA2875	<input type="checkbox"/>	Mid range - Midnight Purple Shroud		-284,36		
JAX0299	<input type="checkbox"/>	Premium - Individual Shroud Colour RAL number required Extended lead lime: + 15 days		781,99	2875	
JAA2865	<input type="checkbox"/>	Premium - Racing Green Shroud RAL6035		○		
JAA2866	<input type="checkbox"/>	Premium - Deep Ocean Blue Satin Shroud RAL5026		○	2865	2866
JAA2867	<input type="checkbox"/>	Premium - Frosty Blue Shroud RAL5025		○		
JAA2868	<input type="checkbox"/>	Premium - Gold Shroud RAL1035		○	2867	2868
RIM INSERT COLOURS						
JAA2882	<input type="checkbox"/>	Mid range - Black		-80,57		
JAA2883	<input type="checkbox"/>	Mid range - Silver		-80,57		
JAA2884	<input type="checkbox"/>	Mid range - Bengal Red		-80,57		
JAA2885	<input type="checkbox"/>	Mid range - Mercury Blue		-80,57		
JAA2886	<input type="checkbox"/>	Mid range - Midnight Purple		-80,57		
JAX2887	<input type="checkbox"/>	Premium - Individual Rim Insert Colour RAL number required Extended lead lime: + 15 days		207,58		
JAA2888	<input type="checkbox"/>	Premium - Racing Green Rim Inserts RAL6035 FR ONLY		○		
JAA2889	<input type="checkbox"/>	Premium - Deep Ocean Blue Satin Rim Inserts RAL5026 FR ONLY		○		
JAA2890	<input type="checkbox"/>	Premium - Frosty Blue Rim Inserts RAL5025 FR ONLY		○		
JAA2891	<input type="checkbox"/>	Premium - Gold Rim Inserts RAL1035 FR ONLY		○		
PERFORMANCE						
FORKS						
JAA2631	<input type="checkbox"/>	Single sided fork		◆		
JAA2632	<input type="checkbox"/>	Double sided fork		○		
CASTORS						
JAA0835	<input type="checkbox"/>	9" (225 mm) x 2.80 (70 mm) Castor, pneumatic		◆		
JAA0836	<input type="checkbox"/>	9" (225 mm) x 2.80 (70 mm) Castor, puncture proof solid tyre		○		
JAA0838	<input type="checkbox"/>	9" (225 mm) x 2.80 (70 mm) Castor, puncture protected		61,61		
JAA0828	<input type="checkbox"/>	8" (200 mm) x 2.50-4 (65 mm) Castor, puncture proof solid tyre	NC : 1223	149,76		
CASTOR LOCK						
JAA1490	<input type="checkbox"/>	Castor Lock		218,01		
DRIVE WHEELS						
JAA0704	<input type="checkbox"/>	DW 14" (355 mm) x 3" (75 mm), Pneumatic		◆		
JAA0705	<input type="checkbox"/>	DW 14" (355 mm) x 3" (75 mm), Solid inlay		238,86		
JAA0706	<input type="checkbox"/>	DW 14" (355 mm) x 3" (75 mm), Puncture protected		61,61		
CTC SUSPENSION						
JAA2870	<input type="checkbox"/>	CTC Suspension Control - Traction - Comfort		◆		
CUSTOMIZED SUSPENSION SETTINGS						
JAA1910	<input type="checkbox"/>	Medium (suggested for up to 90 kg User Weight)		○		
JAA1912	<input type="checkbox"/>	Suspensions Poids Max. Utilisateur Jusqu'à 90 kg		○		
JAA1911	<input type="checkbox"/>	Firm (suggested for up to 110 kg User Weight)		○		
JAA1915	<input type="checkbox"/>	Very firm (suggested for up to 136 kg User Weight)		○		
Motors						
JAA1282	<input type="checkbox"/>	OPS Drive 6 km/h		○		
JAA1283	<input type="checkbox"/>	OPS Drive 10 km/h		◆		
JAA1223	<input type="checkbox"/>	OPS Drive 10 km/h Setting for Ultra High Speed Motor Always combined with 73,5Ah Batteries	NC : 1259, 1260, 0828	○		
BATTERY						
JAA1259	<input type="checkbox"/>	60 Ah Gel	NC : 1223	○		
JAA1260	<input type="checkbox"/>	73,5 Ah Gel	NC : 1450, 1223	◆		

GYROSCOPE				
G-Trac				
JAA1215	<input type="checkbox"/>	G-Trac Module		1 034,12
Chargeur				
JAA1313	<input type="checkbox"/>	OptiCharge Charger 10A (IP44)		◆
SP1606545	<input type="checkbox"/>	Opticharge Charger 10A (UK)		○
ANTI-TIPPERS				
JAA1205	<input type="checkbox"/>	Anti-tipper		◆
POSITIONING OPTIONS				
<i>Think about Bodypoint positioning accessories: belts, harnesses, ankle supports.</i>				
OPTIONS				
<i>Anti-tippers and transport hooks are fitted as standard. The transport hooks comply with the ISO 7176-19: 2001 standard for the transport of people</i>				
LIGHT				
JAA1437	<input type="checkbox"/>	LED Light system with Indicators 30 Lux		◆
JAA2837	<input type="checkbox"/>	LED Light system extra bright with indicators 60 Lux		402,84
KERB RIDER				
JAA1244	<input type="checkbox"/>	Kerb Rider	NC : 2830, 0586, 0589, 0592	291,00
PREPARATION FOR DOCKING STATION				
JAA1450	<input type="checkbox"/>	Preparation for DAHL-Docking station (Adequate headrest is compulsory)	NC : 1260	288,15
TRANSPORTATION KIT 4-POINT TIE DOWNS				
JAA1494	<input type="checkbox"/>	4-Point tie-down (Tested version for using wheelchair as a vehicle seat according to ISO 7176-19) (Adequate headrest is compulsory)	NC : 2053	◆
JAA1401	<input type="checkbox"/>	6-Point tie-down (Tested version for using wheelchair as a vehicle seat according to ISO 7176-19)) required for variants with combined Lift & Tilt module (Adequate headrest is compulsory)	NC : 2052	○
TIE DOWN POINTS				
JAA2894	<input type="checkbox"/>	Easily accessible front tie-down points, additionally mounted for 4- or 6- point-tie-down		91,94
LAP BELTS				
JAA2113	<input type="checkbox"/>	Lap belt with Auto Lock		◆
JAA2701	<input type="checkbox"/>	BP Evoflex Pelvic Stabilizer, Rehab Latch Size L	NC : hip support 2253, 2114, 2115, 2025, 2026, 2027, 2035	156,40
JAA2702	<input type="checkbox"/>	BP Evoflex Pelvic Stabilizer, Rehab Latch Size M	NC : hip support , 2253, 2114, 2115, 2028, 2029, 2030, 2031, 2035	156,40
JAA2703	<input type="checkbox"/>	BP 2-Point Hip Belt, Ctr-Pull, Push Butt, Cinch-Mount Size L	NC : hip support 2253, 2114, 2115, 2025, 2026, 2027, 2035	133,65
JAA2704	<input type="checkbox"/>	BP 2-Point Hip Belt, Ctr-Pull, Push Butt, Cinch-Mount Size M	NC : hip support , 2253, 2114, 2115, 2028, 2029, 2030, 2031, 2035	133,65
JAA2705	<input type="checkbox"/>	2-Point Hip Belt, Dual-Pull, Side-Release Butt. Cinch-Mount Size L	NC : hip support 2253, 2114, 2115, 2025, 2026, 2027, 2035	116,59
JAA2706	<input type="checkbox"/>	BP 2-Point Hip Belt, Dual-Pull, Side-Release Butt. Cinch-Mount Size M	NC : hip support , 2253, 2114, 2115, 2028, 2029, 2030, 2031, 2035	116,59
REARVIEW MIRROR				
JAA1415	<input type="checkbox"/>	Rearview mirror RH	NC : 2213, 2075, 2209, 2265, 2235, 2241, 2267, 2283, 2285, 2287, 2275, 2217	70,14
JAA1339	<input type="checkbox"/>	Rearview mirror LH	NC : 2214, 2076, 2210, 2266, 2236, 2242, 2268, 2284, 2286, 2288, 2276, 2218	70,14
FENDER CASTORS (black)				
JAA1416	<input type="checkbox"/>	Fender for Castors		◆
JAA1417	<input type="checkbox"/>	Fender for Drive wheels		◆
TRAY				
JAA1404	<input type="checkbox"/>	Tray, Swing Away RH	NC : 2014, 2018, 1207, 1707, 2075, 2207, 2209, 2213, 2214, 2217, 2235, 2236, 2267, 2268, 2275, 2276, 2287, 2288, 2283, 2284, 2285, 2286, 2265, 2266, 2241, 2242	478,67
JAA1405	<input type="checkbox"/>	Tray, Swing Away LH	NC : 2014, 2018, 1208, 1708, 2076, 2208, 2210, 2213, 2214, 2218, 2235, 2236, 2267, 2268, 2275, 2276, 2287, 2288, 2283, 2284, 2285, 2286, 2265, 2266, 2241, 2242	478,67
TOOLKIT				
JAA1333	<input type="checkbox"/>	Toolkit		29,38



1244



2701, 2702



2703, 2704



2705, 2706

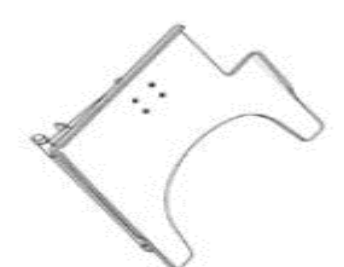

1404 /1405

RAMPS			
1440530	<input type="checkbox"/>	Fiberglass Folding Mono Ramp Folded dimensions: 2000 x 230 mm 16.3 kg - maximum capacity: 300 kg	1 787,68
1654128	<input type="checkbox"/>	Basic ramp 2 telescopic parts in aluminum and non-slip coating. Folded dimensions: 1210 x 194 mm. 8.8 kg per pair - maximum capacity: 270 kg	298,58
1654129	<input type="checkbox"/>	Quick2go Compact 3-part aluminum telescopic ramp with non-slip coating Folded dimensions: 870 x 237 mm 13.6 kg per pair - maximum capacity: 260 kg	559,24
1654130	<input type="checkbox"/>	Aluminium folding mono ramp Folded dimensions: 1824 x 714 mm 13.9 kg - maximum capacity: 300 kg	317,54



1440530



1654128

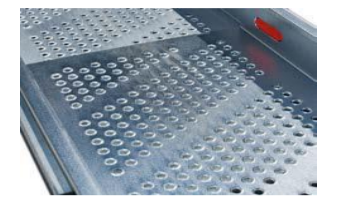

1654129



1654130